

Radian Series Inverter/Charger

GS7048E

GS3548E



GRIDHybrid™

Installation Manual



About OutBack Power Technologies

OutBack Power Technologies is a leader in advanced energy conversion technology. OutBack products include true sine wave inverter/chargers, maximum power point tracking charge controllers, and system communication components, as well as circuit breakers, batteries, accessories, and assembled systems.

Grid/Hybrid™

As a leader in off-grid energy systems designed around energy storage, OutBack Power is an innovator in Grid/Hybrid system technology, providing the best of both worlds: grid-tied system savings during normal or daylight operation, and off-grid independence during peak energy times or in the event of a power outage or an emergency. Grid/Hybrid systems have the intelligence, agility and interoperability to operate in multiple energy modes quickly, efficiently, and seamlessly, in order to deliver clean, continuous and reliable power to residential and commercial users while maintaining grid stability.

Contact Information

Address:	Corporate Headquarters 17825 – 59 th Avenue N.E. Suite B Arlington, WA 98223 USA	European Office Hansastraße 8 D-91126 Schwabach, Germany
Telephone:	+1.360.435.6030 +1.360.618.4363 (Technical Support) +1.360.435.6019 (Fax)	+49.9122.79889.0 +49.9122.79889.21 (Fax)
Email:	Support@outbackpower.com	
Website:	http://www.outbackpower.com	

Disclaimer

UNLESS SPECIFICALLY AGREED TO IN WRITING, OUTBACK POWER TECHNOLOGIES:

(a) MAKES NO WARRANTY AS TO THE ACCURACY, SUFFICIENCY OR SUITABILITY OF ANY TECHNICAL OR OTHER INFORMATION PROVIDED IN ITS MANUALS OR OTHER DOCUMENTATION.

(b) ASSUMES NO RESPONSIBILITY OR LIABILITY FOR LOSS OR DAMAGE, WHETHER DIRECT, INDIRECT, CONSEQUENTIAL OR INCIDENTAL, WHICH MIGHT ARISE OUT OF THE USE OF SUCH INFORMATION. THE USE OF ANY SUCH INFORMATION WILL BE ENTIRELY AT THE USER'S RISK.

OutBack Power Technologies cannot be responsible for system failure, damages, or injury resulting from improper installation of their products.

Information included in this manual is subject to change without notice.

Notice of Copyright

Radian Series Inverter/Charger Installation Manual © 2014 by OutBack Power Technologies. All Rights Reserved.

Trademarks

OutBack Power, the OutBack Power logo, and Grid/Hybrid are trademarks owned and used by OutBack Power Technologies, Inc. The ALPHA logo and the phrase "member of the Alpha Group" are trademarks owned and used by Alpha Technologies Inc. These trademarks may be registered in the United States and other countries.

Date and Revision

February 2014, Revision A

Part Number

900-0144-01-01 Rev A



Table of Contents

Introduction	3
Audience	3
Welcome to OutBack Power Technologies.....	3
Components and Accessories	4
Planning	5
Applications	5
Input Modes.....	6
Renewable Energy	6
Battery Bank	7
Generator	9
Maintenance Bypass Switching	10
Installation	11
Location and Environmental Requirements.....	11
Dimensions.....	11
Tools Required.....	13
Mounting.....	13
Component Mounting.....	15
Removing Front Cover	16
Terminals and Ports	17
Wiring	19
Grounding	19
DC Wiring.....	20
AC Wiring	22
Accessory Wiring.....	24
AUX Wiring	25
Generator Control	26
AC Configurations.....	29
Single-Inverter	29
Multiple-Inverter AC Installations (Stacking)	31
Functional Test.....	40
Preventative Maintenance.....	40
Symbols, Terms, and Definitions	41
Symbols Used	41
Definitions.....	41
Index	43

List of Tables

Table 1	Components and Accessories.....	4
Table 2	Battery Bank Elements.....	8
Table 3	Ground Conductor Size and Torque Requirements.....	19
Table 4	DC Conductor Size and Torque Requirements	21
Table 5	AS4777.3 Acceptance Settings	40
Table 6	Terms and Definitions	41

List of Figures

Figure 1	Radian Series Inverter/Charger.....	3
Figure 2	Radian Inverter and Components.....	4
Figure 3	Applications (Example).....	5
Figure 4	Bypass Switching.....	10
Figure 5	Bypass Switching for Multiple Inverters	10
Figure 6	Inverter Dimensions	11
Figure 7	System Dimensions	12
Figure 8	Installing the Mounting Plate.....	13
Figure 9	Mounting the Inverter	14
Figure 10	Mounting for System Components.....	15
Figure 11	Removing the Front Cover	16
Figure 12	DC Terminals, Ribbon Cables, and Auxiliary Terminals	17
Figure 13	AC Terminals, Ports, and Ground Bus	18
Figure 14	Chassis Ground TBB.....	19
Figure 15	GS7048E and GS3548E Battery Terminals.....	20
Figure 16	DC Cable Hardware (Radian inverter).....	21
Figure 17	AC Terminals	22
Figure 18	AC Sources.....	23
Figure 19	Accessory Connections	24
Figure 20	ON/OFF Jumper and Connections.....	24
Figure 21	AUX Connections for Vent Fan (Example).....	25
Figure 22	AUX Connections for Diversion (Example)	26
Figure 23	Two-Wire Generator Start (RELAY AUX).....	27
Figure 24	Two-Wire Generator Start (12V AUX).....	27
Figure 25	Three-Wire Generator Start (Example)	28
Figure 26	Single-Inverter AC System.....	29
Figure 27	Single-Inverter AC Wiring with GS Load Center.....	30
Figure 28	OutBack Communications Manager and System Display	31
Figure 29	Example of Parallel Stacking Arrangement (Three Inverters).....	33
Figure 30	Parallel AC System.....	34
Figure 31	Parallel AC Wiring with GS Load Centers.....	35
Figure 32	Example of Three-Phase Stacking (Three Inverters)	36
Figure 33	Example of Three-Phase Stacking (Nine Inverters)	36
Figure 34	Three-Phase AC System	38
Figure 35	Three-Phase AC Wiring with GS Load Centers	39



Introduction

Audience

This book provides instructions for the physical installation and wiring of this product. These instructions are for use by qualified personnel who meet all local and governmental code requirements for licensing and training for the installation of electrical power systems with AC and DC voltage up to 600 volts. This product is only serviceable by qualified personnel.

Welcome to OutBack Power Technologies

Thank you for purchasing the OutBack Radian Series Inverter/Charger. This product offers a complete power conversion system between batteries and AC power. It can provide backup power, sell power back to the utility grid, or provide complete stand-alone off-grid service.

- Designed to be integrated with other components as part of an OutBack Grid/Hybrid™ system
- Battery-to-AC inverting which delivers single-phase power (220 to 240 Vac at 50 or 60 Hz)
- Model GS7048E can continuously produce 7 kVA (30 Aac)
Model GS3548E can continuously produce 3.5 kVA (15 Aac)
- Mounts easily with supplied mounting plate
- All terminals exit at the bottom of the inverter, allowing the installer to use a single distribution box; the GS Load Center (GSLC) is specifically designed for this purpose
- Uses spring-based AC terminals instead of screw-based terminals; this eliminates torque requirements and periodic re-tightening
- Uses the MATE3™ System Display and Controller (sold separately) for user interface as part of a Grid/Hybrid system
- Uses the HUB™ Series Communications Manager for networking as part of a Grid/Hybrid system
- Features versatile mounting locations for the MATE3, HUB product, FLEXmax charge controller, and GSLC
- The venting on the cover allows mounting of multiple Radian inverters side by side with minimal clearance between them
- Up to 10 Radian inverter/chargers can be stacked together



Figure 1 Radian Series Inverter/Charger

NOTE: This product has a settable AC output range. In this book, many references to the output refer to the entire range. However, some references are made to 230 Vac or 50 Hz output. These are intended as examples only.

Components and Accessories



IMPORTANT:

This product is not compatible with the OutBack MATE or MATE2 System Display and Controller. Use of these products is not supported with the Radian Series.

Table 1 Components and Accessories

Included in Box	
Radian Series Installation Manual	RTS (Remote Temperature Sensor)
Radian Series Operator's Manual	Hardware Kit
Mounting Bracket	
Optional Components for Attachment to Radian Inverter	
MATE3 System Display and Controller	FLEXmax Series Charge Controller
FW-MB3 (MATE3 bracket)	FW-CCB or FW-CCB2 (charge controller brackets)
GSLC (GS Load Center) series	HUB Series Communications Manager

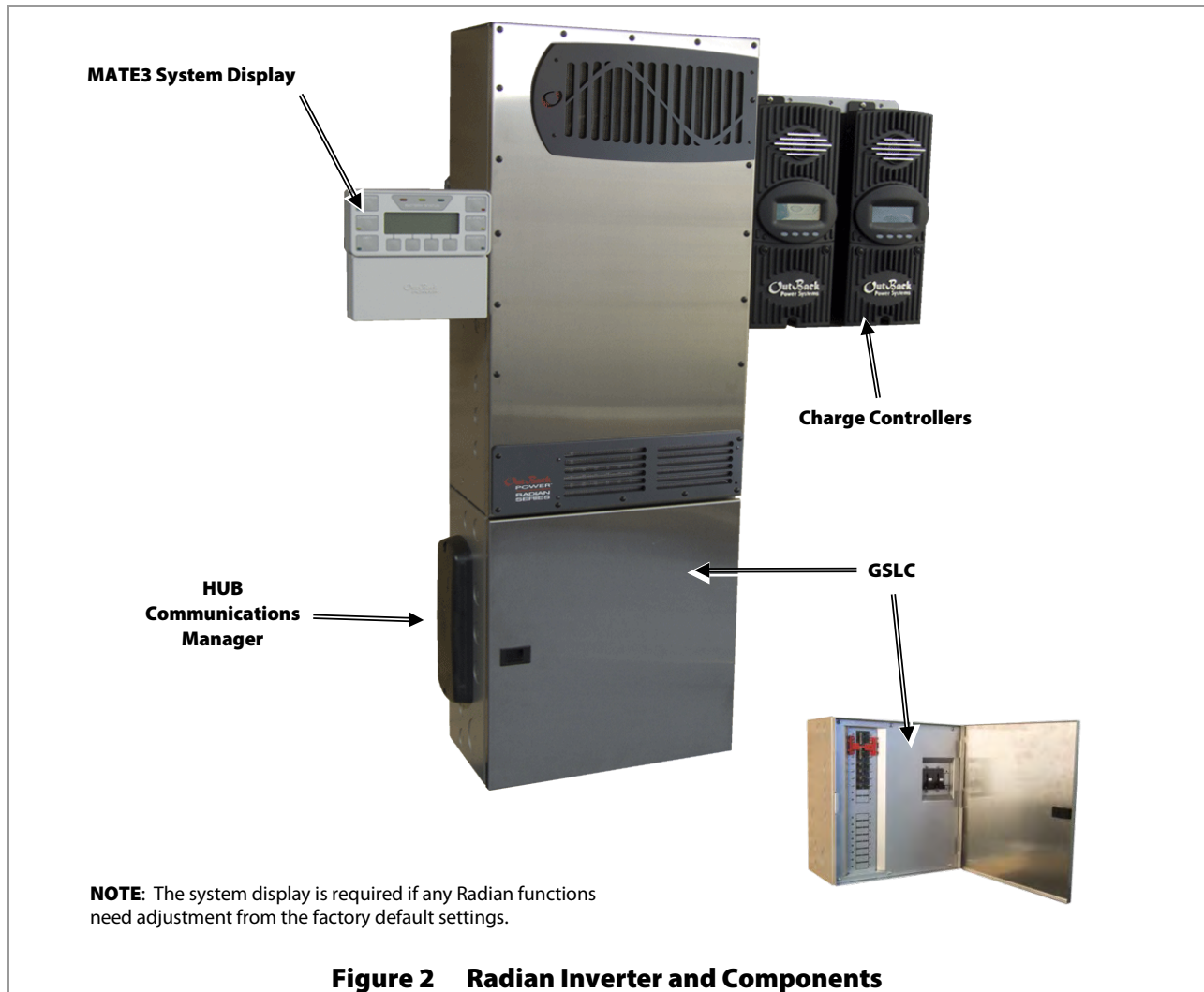



Planning

Applications

The Radian Series Inverter/Charger is intended for both off-grid and grid-interactive (Grid/Hybrid) applications. It is designed to use a battery bank to store energy. It can work in conjunction with photovoltaic (PV) panels to harvest solar energy, as well as wind turbines and other renewable sources. These sources charge the battery, which in turn is used by the inverter.

The Radian inverter has two sets of AC input terminals. Two AC sources, such as a gas or diesel generator and the utility grid, can be connected to the inverter. Other combinations of AC sources are possible.

NOTE: The inverter can only accept one source at a time. The input marked **Grid** has priority, although this can be changed.

The Radian inverter's settings can be changed to accommodate many applications. 

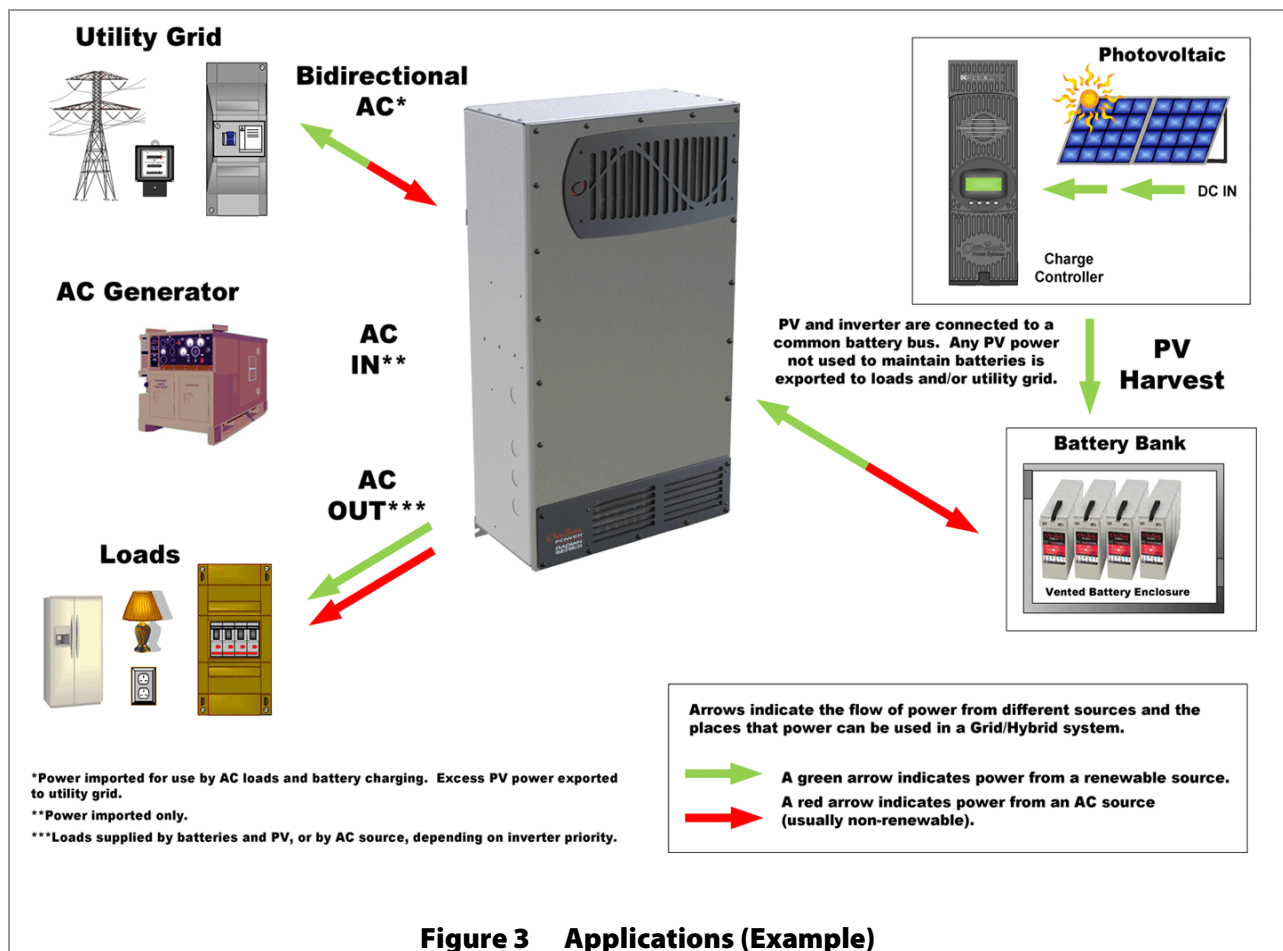

Figure 3 Applications (Example)

Input Modes

The Radian inverter has seven modes of operation. These modes determine how the Radian interacts with an AC source. Each mode has functions and priorities that are intended for a designated application. Each of the Radian's two AC inputs can be set to a different operating mode, so that different applications can be supported.

- **Generator:** This mode is intended for a wide range of AC sources, including generators with a rough or imperfect AC waveform. The Radian can charge from the generator even when the generator is undersized or substandard.
- **Support:** This mode is intended for systems using the utility grid or a generator. AC source size, wiring, or other limitations may require temporary assistance to run very large loads. The Radian adds inverter and battery power to the AC source to ensure that the loads receive the power they require.
- **Grid Tied:** This mode is intended for grid-interactive systems. When renewable energy sources charge the batteries above a selected "target" voltage, the Radian inverter will send the excess energy to any loads. If the loads do not use all the excess energy, then the Radian will return (sell) that energy to the utility grid.
- **UPS:** This mode is intended for systems primarily intended to maintain power to the loads without any interruption when switching between AC input and batteries. The response speed has been increased so that if an AC disconnect occurs the response time will be minimized.
- **Backup:** This mode is intended for systems that have the utility grid or a generator available, but do not have specialty requirements such as selling or support. The AC source will flow through the Radian inverter to power the loads unless power is lost. If power is lost, then the Radian inverter will supply energy to the loads from the battery bank until the AC source returns.
- **Mini Grid:** This mode is intended for systems that have the utility grid as an input and a sizable amount of renewable energy. The system will run off the renewable energy until the battery voltage falls to a specified low level. When this occurs, the Radian inverter will connect to the utility grid to power the loads. The Radian inverter will disconnect from the utility grid when the batteries are sufficiently recharged.
- **Grid Zero:** This mode is intended for systems that have the utility grid as an input and a sizable amount of renewable energy. The system will remain connected to the utility grid, but will only draw power from it when no other power is available. The default power sources are the batteries and renewable energy, which attempt to "zero" the use of the AC source. The batteries are discharged and recharged while remaining grid-connected.

See the *Radian Series Inverter/Charger Operator's Manual* for additional information on these modes, including the reasons and considerations for using each mode.

Renewable Energy

The Radian Series Inverter/Charger cannot connect directly to photovoltaic arrays, wind turbines, or other renewable sources. As a required part of a Grid/Hybrid system, the batteries are the inverter's primary source of power. However, if the renewable sources are used to charge the batteries, the inverter can use their energy by drawing it from the batteries.



The renewable source is always treated as a battery charger, even if all of its power is used immediately. The renewable source must have a charge controller or some way to prevent overcharging. OutBack Power's FLEXmax family of charge controllers can be used for this purpose, as can other products.

The GSLC will receive the mechanical and electrical connections for up to two FLEXmax charge controllers. It can receive the electrical connections for two FLEXmax Extreme charge controllers.

Battery Bank

When planning a battery bank, consider the following:

- **Cables:** Recommendations for battery cable size and length are shown on page 20. The maximum length will determine the placement of the battery bank. Other local codes or regulations may apply and may take priority over OutBack recommendations.
- **Battery Type:** The Radian inverter/charger uses a three-stage charge cycle.
 - ~ The cycle was designed for lead-chemistry batteries intended for deep discharge. These include batteries for marine, golf-cart, and forklift applications. They also include gel-cell batteries and absorbed glass-mat (AGM) batteries. OutBack Power recommends the use of batteries designed specifically for renewable energy applications. Automotive batteries are strongly discouraged and will have a short life if used in inverter applications.
 - ~ Each stage of the charging cycle can be reconfigured or omitted from the cycle if necessary. This programming is performed using the system display. The charger can be customized to charge a wide range of battery technologies including nickel, lithium-ion, and sodium-sulfur batteries.
 - ~ The Radian inverter/charger is designed to work with a 48-volt battery bank. Before constructing a battery bank, confirm the nominal voltage of individual batteries.
- **Charger Settings and Maintenance:** A vented battery enclosure may be required by electric code and is usually recommended for safety reasons. It may be necessary to use a fan to ventilate the battery enclosure. Batteries must be regularly maintained according to the instructions of the battery manufacturer.

	<p>IMPORTANT:</p> <p>Battery charger settings need to be correct for a given battery type. Always follow battery manufacturer recommendations. Making incorrect settings, or leaving them at factory default settings, may cause the batteries to be undercharged or overcharged.</p>
	<p>CAUTION: Hazard to Equipment</p> <p>Batteries can emit vapors which are corrosive over long periods of time. Installing the inverter in the battery compartment may cause corrosion which is not covered by the product warranty. (Sealed batteries may be an exception.)</p>

- **Bank Size:** Battery bank capacity is measured in amp-hours. Determine the required bank specifications as accurately as possible, beginning with the items below. This avoids underperformance or wasted capacity.

These ten items are obtainable in different places, summarized in Table 2 on the next page. Some of the information is specific to the site or application. Some can be obtained from the battery manufacturer. Information on OutBack products is available from OutBack Power Technologies or its dealers.

- A. Size of load:
 - B. Daily hours of use:
 - C. Days of autonomy:
- } These are the most basic and essential factors used to determine bank size.
- D. Application: This often helps define or prioritize the previous three items. Off-grid systems often require enough capacity to last for an extended period before recharging. Grid-connected systems frequently need only enough capacity for short-term backup during outages.
 - E. Conductor efficiency: Wire size and other factors will waste power due to resistance and voltage drop. Typical acceptable efficiency is 96 to 99%.
 - F. Inverter efficiency: Radian specifications list "Typical Efficiency" to help estimate operating loss.
- } Any losses are essentially amp-hour capacity that the system cannot use. The battery bank size can be increased to account for losses.

- G. System DC voltage: The Radian inverter requires nominal 48 Vdc to operate.
- H. Battery voltage: Most individual battery voltages are less than the system DC voltage. The batteries need to be placed in series to deliver the correct voltage.
- I. Capacity: Battery capacity, which is measured in amp-hours, is not usually a fixed number. It is specified based on the rate of discharge. For example, the OutBack EnergyCell 200RE is rated at 154.7 Ahr when discharged at the 5-hour rate (to terminal voltage 1.85 Vpc). This is a high rate of discharge that would hypothetically drain the battery in 5 hours. The same battery is rated at 215.8 Ahr when used at the 100-hour rate. Use the appropriate discharge rate (correlated to the expected loads) to measure the capacity of a battery. Use battery specifications for terminal voltage 1.85 Vpc whenever possible.
- J. Maximum depth of discharge (DoD): Most batteries cannot be discharged below a certain level without damage. The bank requires enough total capacity to keep this from happening.

Table 2 Battery Bank Elements

Item	Source of information
A. Load Size	Site-specific
B. Daily Hours	Site-specific
C. Days of Autonomy	Site-specific
D. Application	Site-specific
E. Conductor Efficiency	Site-specific
F. Inverter Efficiency	Inverter manufacturer
G. System Vdc	Inverter manufacturer
H. Battery Vdc	Battery manufacturer
I. Capacity	Battery manufacturer
J. Maximum DoD	Battery manufacturer

To Calculate Minimum Battery Bank Size (refer to Table 2 for letter designations):

1. The load size, item A, is measured in watts. Compensate this figure for efficiency loss. Multiply the conductor efficiency by the inverter efficiency (E x F). (These items are represented as percentages, but may be displayed as decimals for calculation.) Divide item A by the result.
2. Convert the compensated load into amperes (Adc). Divide the step 1 result by the system voltage (item G).
3. Determine the daily load consumption in ampere-hours (amp-hours, or Ahr). Multiply the step 2 result by the daily usage hours (item B).
4. Adjust the total for required days of autonomy (the days the system must operate without recharging) and the maximum DoD. Multiply the step 3 result by C and divide by J.

The result is the total amp-hour capacity required for the battery bank.

5. Determine the number of parallel battery strings required. Divide the Ahr figure from step 4 by the individual battery capacity (I). Round the result to the next highest whole number.
6. Determine the total number of batteries required. Divide the system voltage by the battery voltage (G ÷ H). Multiply the result by the step 5 result.

The result is the total required quantity of the chosen battery model.

EXAMPLE #1

- | | |
|---|--|
| A. Backup loads: 1.0 kW (1000 W) | 1) $A \div [E \times F]$ $1000 \div (0.98 \times 0.92) = 1109 \text{ W}$ |
| B. Hours of use: 8 | 2) $1 \div G$ $1109 \div 48 = 23.1 \text{ Adc}$ |
| C. Days of autonomy: 1 | 3) $2 \times B$ $23.1 \times 8 = 184.9 \text{ Ahr}$ |
| D. Grid-interactive system (GS3548E inverter) | 4) $[3 \times C] \div J$ $[184.9 \times 1] \div 0.8 = 231.1 \text{ Ahr}$ |
| E. Conductor efficiency: 98% (0.98) | 5) $4 \div I$ $231.1 \div 199.8 = 1.156$ |
| F. Inverter efficiency: 92% (0.92) | (rounded to 2) |
| G. System voltage: 48 Vdc | 6) $[G \div H] \times 5$ $[48 \div 12] \times 2 \text{ strings} = 8$ |
| H. Batteries: OutBack EnergyCell 220GH (12 Vdc) | batteries |
| I. Capacity at 8-hour rate: 199.8 Ahr | |
| J. Maximum DoD: 80% (0.8) | |

EXAMPLE #2

A. Backup loads: 1.75 kW (1750 W)	1) $A \div [E \times F]$	$1750 \div (0.97 \times 0.92) = 1961.0 \text{ W}$
B. Hours of use: 8	2) $1 \div G$	$1961.0 \div 48 = 40.9 \text{ Adc}$
C. Days of autonomy: 2	3) $2 \times B$	$40.9 \times 8 = 326.8 \text{ Ahr}$
D. Off-grid system (GS3548E inverter)	4) $[3 \times C] \div J$	$[326.8 \times 2] \div 0.5 = 1307.3 \text{ Ahr}$
E. Conductor efficiency: 97% (0.97)	5) $4 \div I$	$1307.3 \div 167.5 = 7.8 \text{ (rounded to 8)}$
F. Inverter efficiency: 92% (0.92)	6) $[G \div H] \times 5$	$[48 \div 12] \times 8 \text{ strings} = 32 \text{ batteries}$
G. System voltage: 48 Vdc		
H. Batteries: OutBack EnergyCell 200RE (12 Vdc)		
I. Capacity at 8-hour rate: 167.5 Ahr		
J. Maximum DoD: 50% (0.5)		

Generator

These Radian models can work with any single-phase generator that delivers reliable AC power at the appropriate voltage and frequency. These models can work with three-phase generators when stacked for three-phase output.

- The Radian inverter/charger can provide a start signal to control an automatic start generator. If automatic generator starting is required, the generator must be an electric-start model with automatic choke. It should have two-wire start capability. For other configurations, additional equipment may be required.
- In any configuration, the inverter may need to be programmed using the system display. Perform all programming according to the specifications of the generator and the required operation of the inverter. Parameters to be programmed may include generator size, automatic starting requirements, and potential fluctuations in generator AC voltage.

Generator Sizing

A generator should be sized to provide enough power for all the loads and the battery charger.

- Available generator power may be limited by ratings for circuit breakers and/or generator connectors. The maximum allowed AC circuit breaker size is 50 Aac per Radian inverter/charger.
- The generator must be able to provide current to all inverters. Minimum generator wattage¹ is usually recommended to be twice the wattage of the inverter system. Many generators may not be able to maintain AC voltage or frequency for long periods of time if they are loaded more than 80% of rated capacity.
- A generator that is to be installed in a building usually should not have a bond between the neutral and ground connections. The generator should only be bonded if there is a specific need. Local or national electric codes may require the neutral and ground to be bonded at the main electrical panel. See page 22 for more information on neutral-ground bonding.

¹This is the wattage value after deratings for the following: peak versus continuous power, load power factor considerations, fuel type, altitude, and ambient temperature.

Maintenance Bypass Switching

Inverter systems are often equipped with AC maintenance bypass switches or interlocks. If the inverter system ever needs to be shut down or removed, the AC sources and loads must be disconnected. A bypass device allows the AC source to deliver power directly to the loads, bypassing the inverter. This can minimize disruption to the system and avoids the need for extensive rewiring.

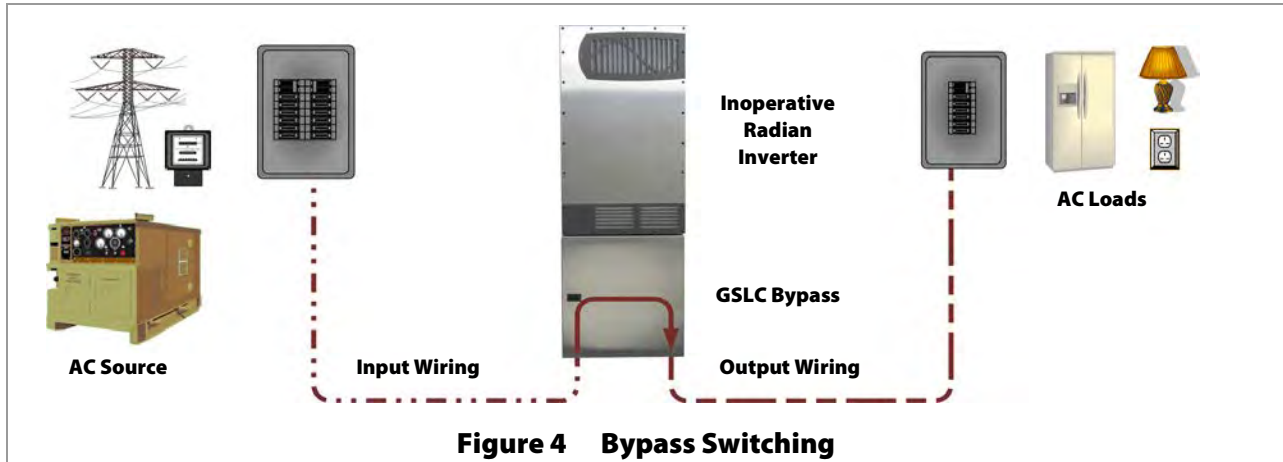

The GS Load Center (GSLC) can be equipped with bypass circuit breakers for this purpose. However, if multiple Radian inverters are stacked in a single system, then the GSLC bypass kits should not be used. The bypass function must be simultaneous for all inverters. The GSLC bypass kits operate independently, not simultaneously.

Both manual and automatic double-throw bypass switches are commonly available in a range of sizes and options. These are highly recommended for systems with more than a single inverter.



WARNING: Shock Hazard or Equipment Damage

Using independent bypass devices on multiple inverters can result in power being routed to inappropriate places. This could create an electric shock hazard or damage the equipment.

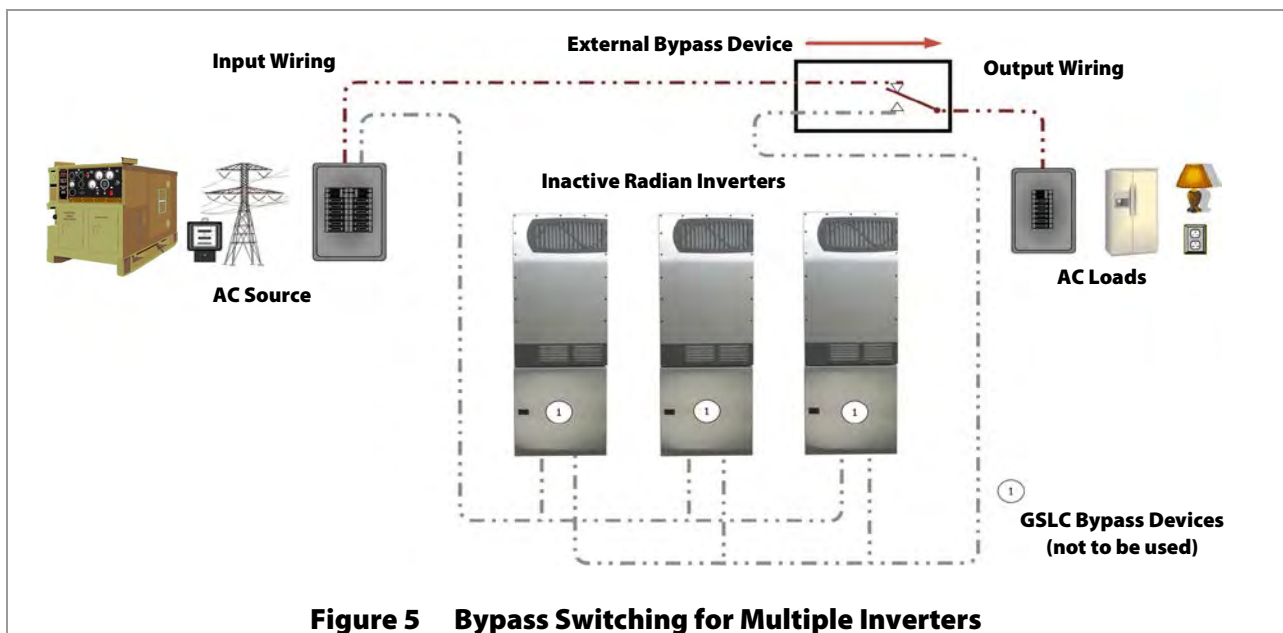



Installation

Location and Environmental Requirements

Radian Series Inverter/Chargers must be located in a weather-proof enclosure or enclosed area. It is not designed for exposure to water or excessive wind-blown dust and debris. It carries an Ingress Protection (IP) rating of 20 and a Relative Humidity (RH) rating of 93%.

The Radian inverter must be wall-mounted in an upright position. The inverter is not approved for mounting in any other position or orientation.

- Recommended minimum clearance is 5 to 10 cm (2 to 4 inches) for the front and top of the inverter.
- The sides and bottom may be enclosed or obscured with no restriction when mounting accessory devices or one other Radian inverter. If more than two Radian inverters are installed side by side with the GSLC, the inverters should be separated by at least 2.3 cm (0.9 inches) to accommodate the GSLC hinged doors.
- The Radian inverter will function best if operated in a temperature range of -20°C to 25°C (-4°F to 77°F). At temperatures up to 50°C (122°F), all inverter components meet their specifications, but the inverter's power is derated. It can function in environments as cold as -40°C (-40°F) and as warm as 60°C (140°F), but it may not meet all component specifications. This temperature range also applies to storage.
- The specifications are listed in the *Radian Series Inverter/Charger Operator's Manual*.

Dimensions

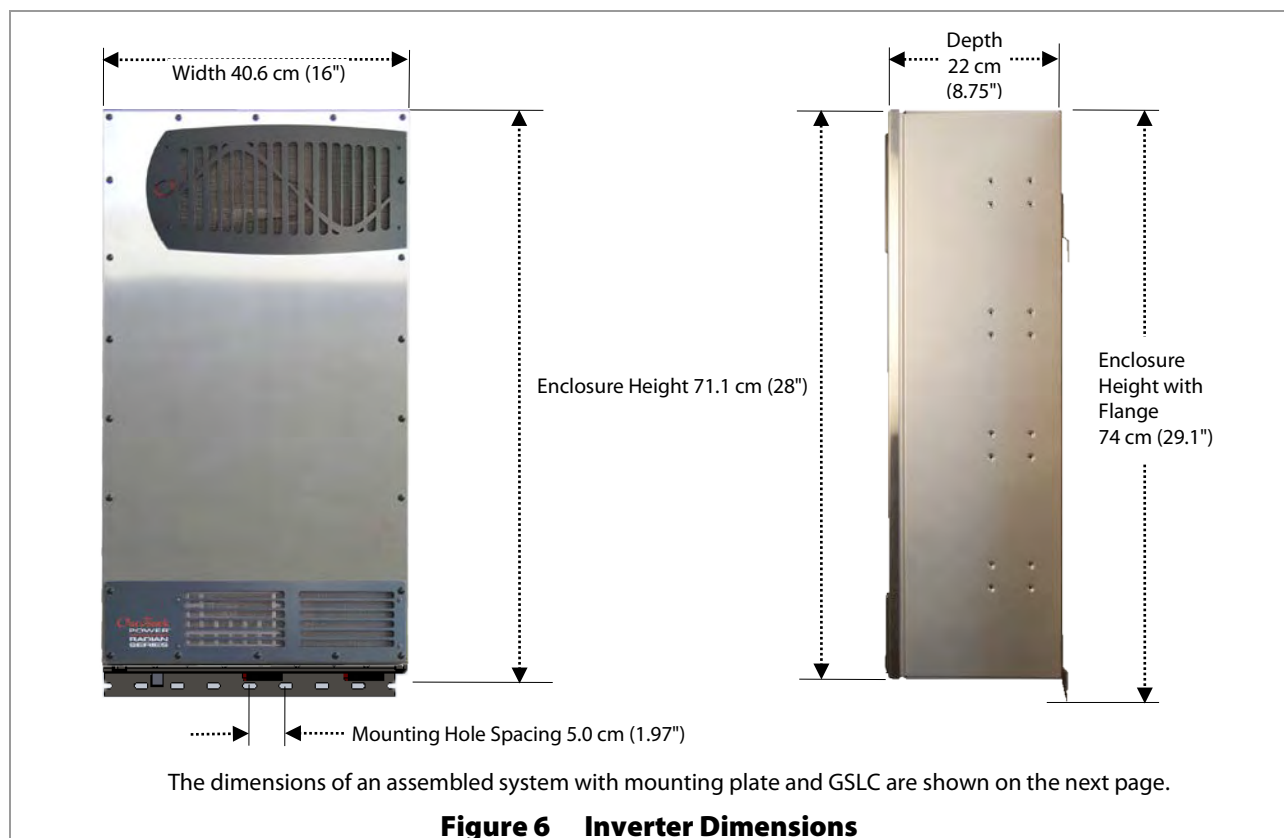

Installation

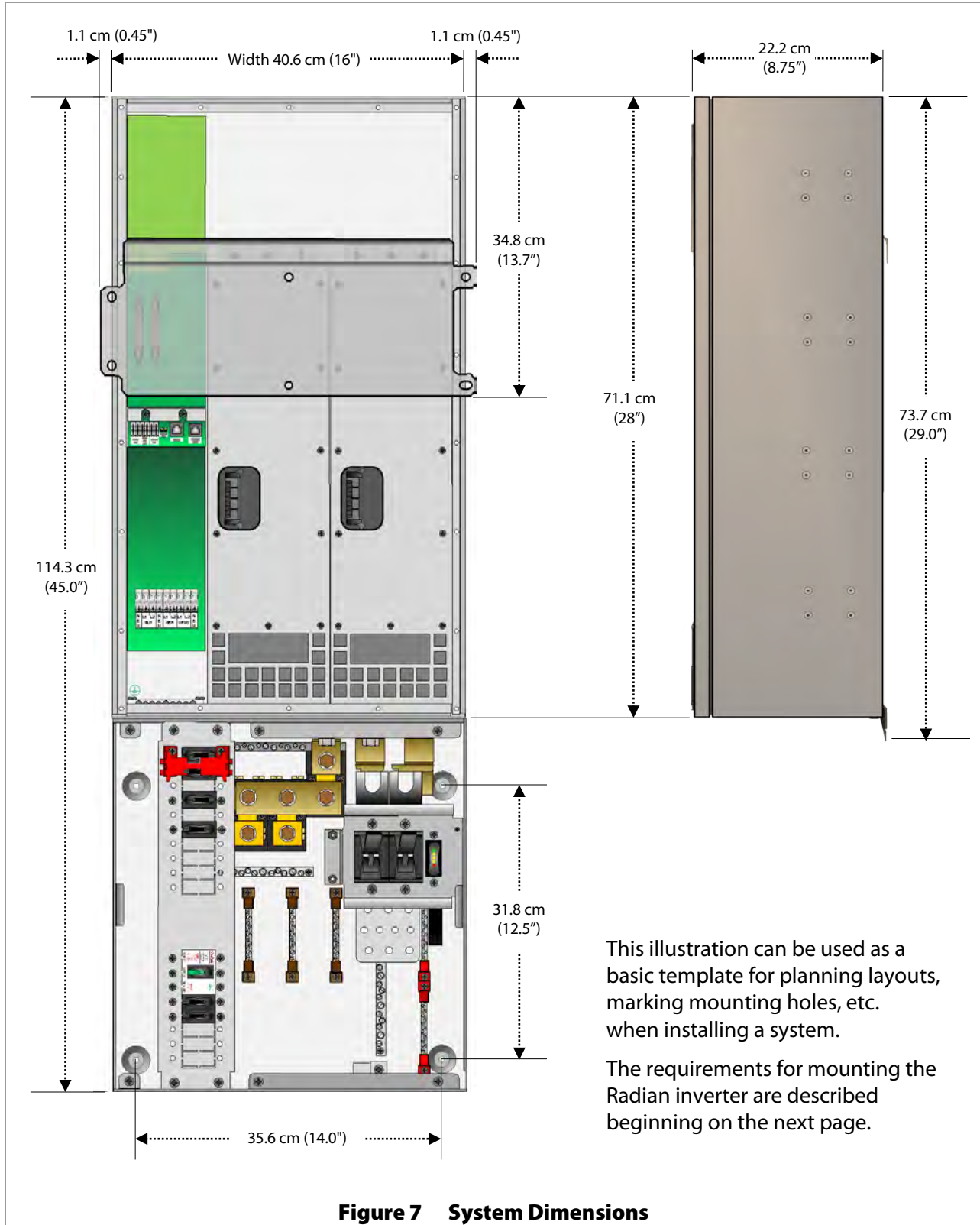

Tools Required

The following tools may be required for this installation:

- Wrench and socket sets; should include torque and ratchet wrenches; also reversible (stubby) wrenches for narrow access
- Wire cutters/strippers
- Insulated screwdriver set; should include a #2 Phillips screwdriver 38 to 41 cm long
- Long-nose pliers
- DVM or Voltmeter

Mounting

- Two or more people may be needed to install the Radian inverter/charger due to its weight.
- Mount and secure each component before attaching any wiring. Local or national wiring codes may require the bottom of the inverter to be enclosed. The GS Load Center was specifically designed for this purpose.
- Avoid large air gaps behind the Radian inverter/charger and its mounting plate. These can result in louder mechanical noise during heavy inverting or charging. Mount the plate on a flat, solid mounting surface.



IMPORTANT:

Use correct fasteners to secure the mounting plate and the Radian inverter/charger to the mounting surface. OutBack cannot be responsible for damage to the product if it is attached with inadequate fasteners.

The Radian inverter/charger comes equipped with a mounting plate, as shown in Figure 8.

The Radian inverter is mounted using these steps.

1. The mounting plate is to be screwed or bolted directly to a solid mounting surface such as wall studs. (See Figure 8.) Lag screws are provided for this purpose.
 - ~ The plate is designed to mount on wall studs with a spacing of 40.6 cm (16"). If the structure or mounting surface is constructed differently, then ensure the mounting surface is reinforced for the appropriate amount of weight.
 - ~ If multiple Radian inverter/chargers are being installed, all mounting plates should be installed first. The inverters can be mounted and secured one at a time when this is done.

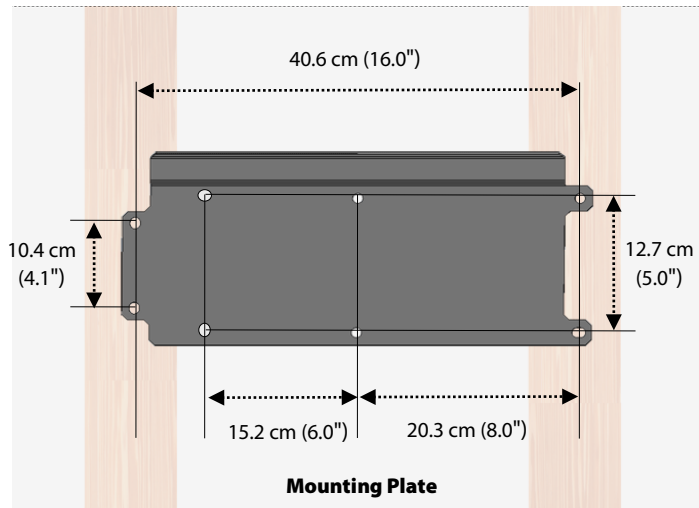

Continued on the next page...

Figure 8 Installing the Mounting Plate

Installation

...continued from the previous page...

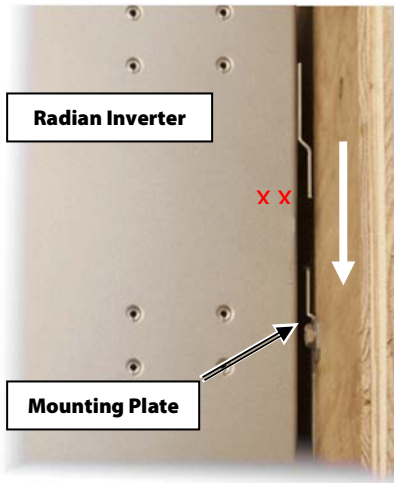

2. Place the Radian inverter against the wall and slide it directly over the upper lip of the mounting plate. The inverter's mounting flange should come to rest within the lip so that it hangs securely.

To assist in alignment, dimples have been placed on the side of the unit to mark the lower edge of the flange. In the picture to the left, the two X symbols show the location of the dimples.

3. Align the left edge of the inverter with the left edge of the mounting plate. This will expose the right edge of the plate, allowing easy installation of another Radian inverter/charger in the future. All additional inverters are mounted to the right of the existing unit.

The unit shown to the right is not aligned with the mounting plate, as the plate is still visible. In this example, it should slide to the left so that the plate is entirely covered.



NOTE: If the GS Load Center is used with the Radian inverter, the following step should be omitted.

4. Once aligned, secure the Radian inverter to the stud using a lag screw (provided) in the left corner of the inverter's bottom flange. Securing the inverter this way will prevent it from dislodging from the mounting plate in the event of an earthquake or similar event.

NOTE: The left corner is used for securing the inverter to a stud. If the Radian inverter is mounted on plywood or a similar wide-area mounting surface as shown, any of the slots in the mounting flange may be used.



WARNING: Shock Hazard

When the inverter is used with other metal chassis, make sure that all chassis are grounded appropriately. (See the grounding instructions on page 18.) Grounding other chassis may involve metal-to-metal contact or separate ground wires.

Figure 9 Mounting the Inverter

Component Mounting

The top of the GS Load Center (GSLC) connects to the bottom of the Radian inverter using four keyhole slots. The keyhole slots fit over four screws on the bottom of the inverter that secure the GSLC to the inverter when they are tightened. (The long screwdriver recommended on page 13 may be needed to reach these screws.) The GSLC should be secured to the wall using screws or wall anchors. The GSLC also makes a mechanical connection to the Radian using bus bars that bolt to the inverter's DC terminals. Other connections are wired as necessary.

Several system components can mount directly onto the Radian inverter or the GSLC. The MATE3 System Display and the HUB Communications Manager can easily be mounted on the left side of the system. Up to two FLEXmax 60 or 80 charge controllers can be mounted on its right side.

NOTE: The FLEXmax controller requires mounting brackets (see below). The conduit provided with these brackets is long enough to wire the FLEXmax directly to the GSLC. Additional conduit may be necessary when mounting on the inverter. The image on the right shows GSLC mounting. See Figure 2 on page 4 for other configurations.

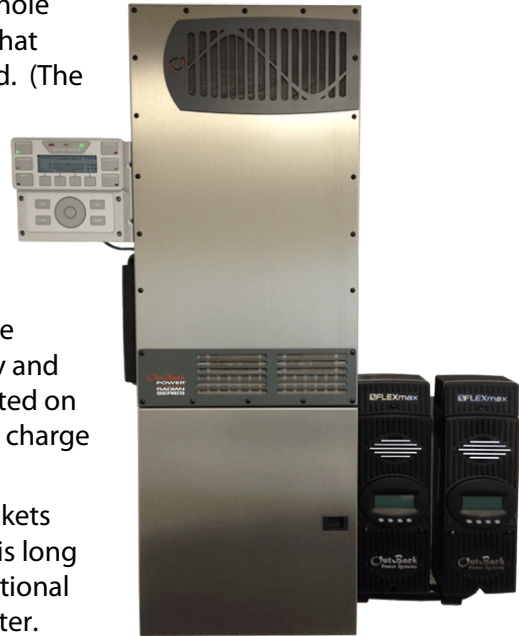

For the MATE3:

To fit on the Radian inverter's left side, the MATE3 requires the FW-MB3 mounting bracket. Holes are provided on the upper and lower left side to attach the FW-MB3. For more information, see the FW-MB3 instruction sheet.

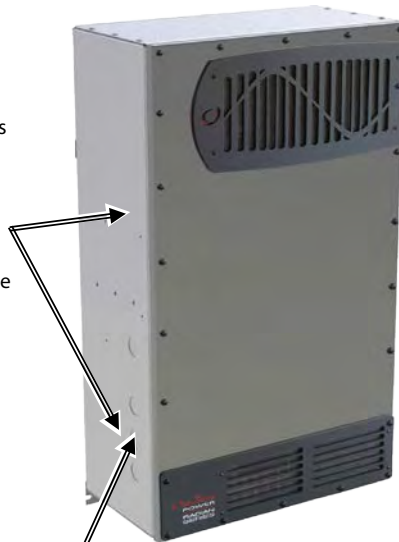

For the HUB:

To fit on the Radian inverter's left side, the HUB Communications Manager uses two mounting holes and three knockouts.

For the FLEXmax charge controller:

To fit on the Radian inverter's right side, the FLEXmax charge controllers require the FW-CCB or FW-CCB2 mounting brackets. To accommodate many possible mounting requirements, four sets of mounting holes have been provided for the brackets.

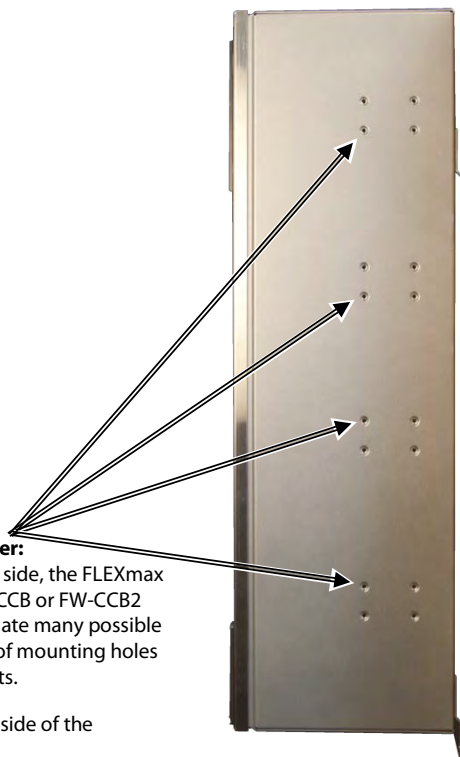

NOTE: The OutBack FLEXmax Extreme should be installed on the wall to either side of the GSLC for direct wiring access and does not require additional brackets.

Figure 10 Mounting for System Components

Removing Front Cover

The front cover must be removed in order to access the Radian inverter's AC terminals and other connections. These include the Remote and Batt Temp ports, as well as several sets of auxiliary terminals.

Twenty-two machine screws are located around the perimeter. Remove these screws with a #2 Phillips screwdriver. Once they are removed, the cover can be lifted off.

NOTE: The screws which secure the plastic plates to the cover do not need to be removed.

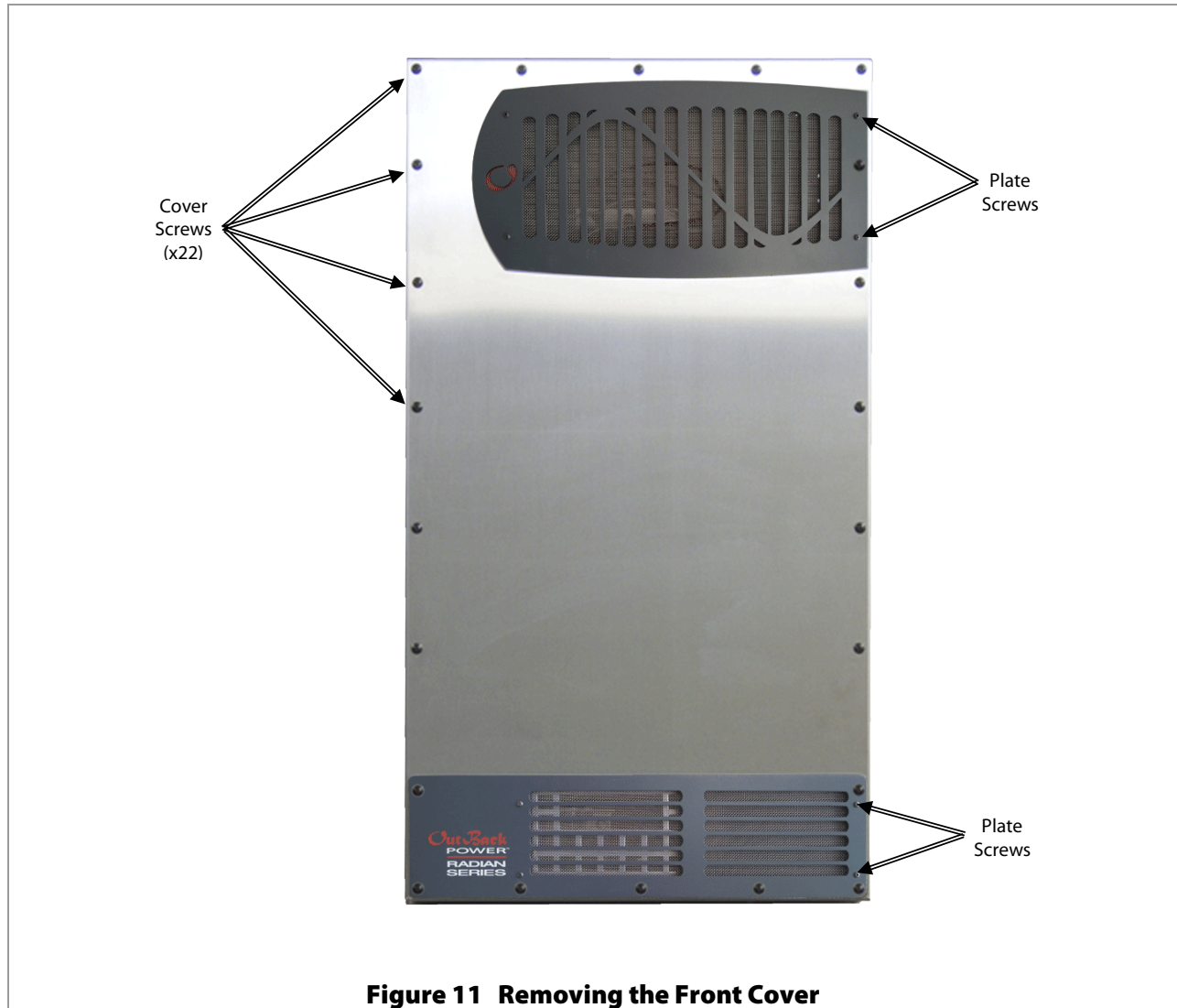
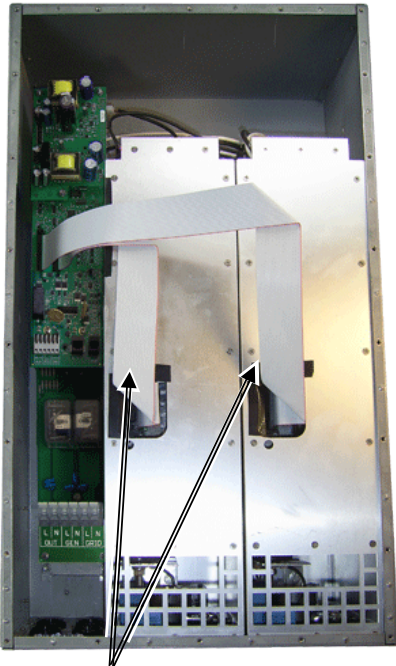

Figure 11 Removing the Front Cover

NOTE: The Radian inverter may ship with only a few screws installed to make it easier to perform the initial installation. The remaining screws are included in the hardware kit.

Terminals and Ports



RIBBON CABLES: Connects the Radian's power modules and control board. See Warning below.



DC TERMINALS: Connects to the battery cables and DC system. There are two DC positive and two DC negative terminals. Each DC positive terminal requires separate cables and separate overcurrent protection. See page 20 for instructions.

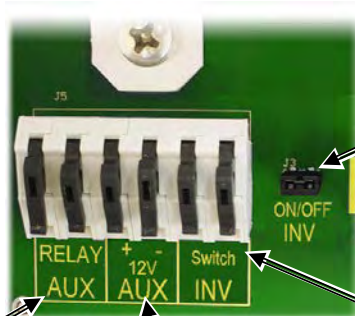

RELAY AUX: Relay contacts with no voltage (10 amps at 250 Vac or 30 Vdc). The relay can be switched on and off for many functions. See page 25 for details.

12V AUX: Delivers 12 Vdc up to 0.7 amps (8.4 watts). The output can be switched on and off for many functions. See page 25 for details.

ON/OFF INV JUMPER (J3): Overrides the **SWITCH INV** terminals when installed. When installed, the inverter is ON. The ON or OFF states can then only be controlled by the system display. **NOTE:** J3 is installed to the ON position during manufacture, but the Radian inverter is given an external OFF command at the same time. Its initial state will be OFF.

SWITCH INV: Receives wires for a manual on/off switch to control the inverter. See page 24 for instructions.

NOTE: The ON/OFF INV jumper (J3) overrides these terminals when installed. (See above.)

The functions for each set of AUX contacts can be programmed using the system display.



Figure 12 DC Terminals, Ribbon Cables, and Auxiliary Terminals



WARNING: Shock Hazard and Equipment Damage

It may be necessary to remove the ribbon cables in the course of servicing the Radian. (This is detailed in the Radian service manual.) The cables must never be removed until all power has been disconnected from the Radian for a minimum of one minute. If the cables are removed prematurely, the Radian's capacitors will retain a sizable charge, which can cause electrical shock or severe equipment damage during normal handling. This damage is not covered under the unit's warranty.

Installation

CONTROL WIRING TERMINAL BLOCK:

Receives control wires for a variety of functions, including generator control. See facing page for terminal descriptions.

AC TERMINAL BLOCK:

Receives AC input wires for two input sources. Also receives AC output wires. All neutral wires are electrically common. See page 22 for instructions.

REMOTE and BATTERY TEMP PORTS:

Receive the RJ45 and RJ11 plugs from the MATE3 system display and Remote Temp Sensor. See page 24 for instructions.

GROUND BUS: Receives ground wires from multiple locations. See page 19 for instructions.

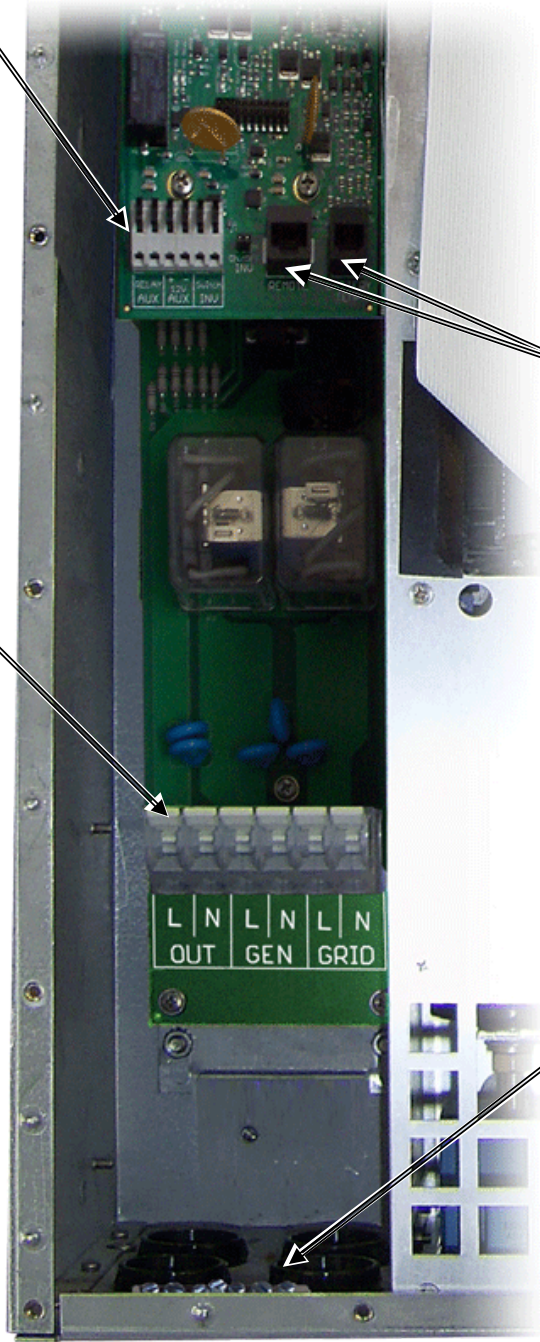

Figure 13 AC Terminals, Ports, and Ground Bus



WARNING: Shock Hazard

After installation, do not remove the covers while the inverter has any source of power. See the Operator's Manual for the shutdown procedure before removing the covers.

Wiring

It will be necessary to remove knockouts from the chassis to run wires. Bushings are included with the hardware kit to protect the wires. Make sure to install these bushings in the holes.

Use copper wire only. Wire must be rated at 75°C or higher.

Grounding



	<p>WARNING: Shock Hazard</p> <ul style="list-style-type: none"> ➤ This unit meets the IEC requirements of Protection Class I. ➤ The unit must be connected to a permanent wiring system that is grounded according to the IEC 60364 TN standard. ➤ The input and output circuits are isolated from ground. The installer is responsible for system grounding according to all applicable codes. ➤ For safety, the neutral and ground conductors should be mechanically bonded. OutBack does not bond these conductors within the inverter. Make sure that no more than one bond is present in the AC system at any time. Some codes require the bond to be made at the main panel only. ➤ The GS Load Center (GSLC) is equipped with a neutral-ground bond. If bonding is required to be in another location, the bond in the GSLC may need to be removed.
	<p>WARNING: Shock Hazard</p> <p>For all installations, the negative battery conductor should be bonded to the grounding system at only one point. If the OutBack GFDI is present, it can provide the bond. (The GSLC is also equipped with its own bond, which may need to be removed.)</p>
	<p>IMPORTANT:</p> <p>Most OutBack products are not designed for use in a positive-grounded system. If it is necessary to build a positive-grounded system with OutBack products, contact OutBack Technical Support at +1.360.618.4363 before proceeding. Additionally, consult the online forum at www.outbackpower.com/forum/, where this subject has been discussed extensively.</p>

Table 3 Ground Conductor Size and Torque Requirements

Terminal Location	Minimum Conductor Size	Torque Requirements
Ground TBB	16 mm ² or #6 AWG (0.025 in ²)	2.8 Nm (25 in-lb)

The inverter’s ground terminal bus bar (TBB) may be used for making all ground connections to other parts of the system. Examples include inverter equipment grounding, generator grounding, load panel grounding, and main earth ground wire. When the GSLC is used, make a connection from the inverter to the ground TBB in the GSLC.

This TBB accepts up to 25 mm² or #4 AWG (0.033 in²) wire.

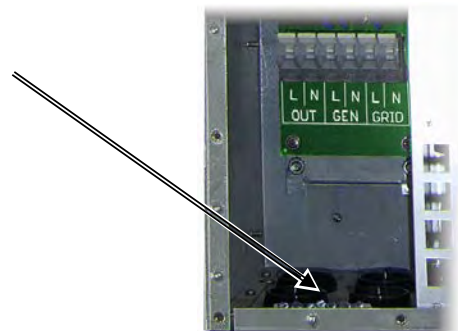



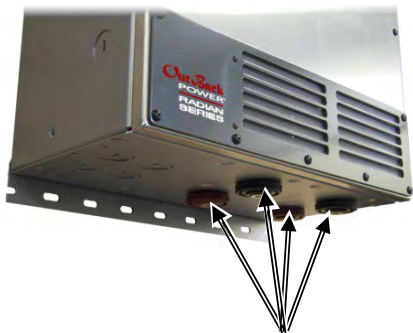

Figure 14 Chassis Ground TBB

DC Wiring

	WARNING: Shock Hazard
	Use caution when working in the vicinity of the inverter's battery terminals.
	CAUTION: Equipment Damage
	Never reverse the polarity of the battery cables. Always ensure correct polarity.
	CAUTION: Fire Hazard
	<ul style="list-style-type: none"> ➤ The installer is responsible for providing overcurrent protection. Install a circuit breaker or overcurrent device on each DC positive (+) conductor to protect the DC system. ➤ Never install extra washers or hardware between the mounting surface and the battery cable lug. The decreased surface area can build up heat. See the hardware diagrams on page 21.
	IMPORTANT:
	Table 4 contains OutBack's recommendations for minimum cable sizes. Other codes may supersede OutBack's requirements. Consult local codes for final size requirements.



The Radian inverter has four battery cable terminals, two positive and two negative. Each terminal is a threaded hole which accepts a hex bolt (provided). Notes on assembly and cabling are shown on the next page.



GS7048E



GS3548E

	IMPORTANT:
	<ul style="list-style-type: none"> ➤ The Radian GS7048E contains two internal power modules, each with its own set of DC terminals. Both sets of terminals must be connected to battery power for the inverter to work correctly. ➤ The Radian GS3548E contains a single power module which occupies the space on the left. Although it has two pairs of terminals, only the pair on the left is functional. The battery cables must be connected to these terminals. The terminals on the right must not be connected to battery power.

Figure 15 GS7048E and GS3548E Battery Terminals

Table 4 DC Conductor Size and Torque Requirements

Inverter	Nominal DC Amps (Minimum, per breaker) (Derated 125%)	Conductor Size (Minimum, per breaker)	Breaker Size
GS7048E	91	70 mm ² or 2/0 AWG (0.105 in ²)	175 Adc/AIC 10kA
GS3548E	91	70 mm ² or 2/0 AWG (0.105 in ²)	175 Adc/AIC 10kA
Terminal Location		Torque Requirements	
Inverter DC Terminals		6.9 Nm (60 in-lb)	
Battery Terminals		See battery manufacturer's recommendations	

When installing DC cables:

- Make certain DC circuit breakers are turned to the off position, or fuses are removed, before proceeding.
- Battery positive (+) and negative (-) cables should not exceed 3 m (10 ft) each to reduce voltage loss and other effects.
- The modular construction of the GS7048E requires the use of two DC circuit breakers or fuses.
- The cables for each overcurrent device must **each** be sized appropriately. Alternately, a single cable or bus may be used if sized to the minimum total ampacity. The cables listed above are for each inverter in a system. In a multiple-inverter system, each inverter requires its own cables and overcurrent devices of the size indicated.
- Install all overcurrent devices on the positive cable.
- Tie, tape, or twist positive and negative cables together to reduce self-inductance. Run positive and negative cables through the same knockouts and conduit.

NOTE: Do not install hardware in a different order from the illustrations shown in Figure 16. In all cases the battery cable lug must be the first item installed. It must make solid contact with the surface.

- If the battery cables are connected directly to the Radian inverter, the hardware should be arranged as shown in image A. The inverter's battery terminal is a threaded hole which accepts a hex bolt (provided). The battery cable lug must have a 0.79 cm (5/16") diameter hole.
- If the inverter is installed with the GS Load Center (GSLC), follow GSLC instructions for cable and hardware installation. The hardware should be arranged according to the appropriate image below.
- GSLC models used with the GS7048E inverter are equipped with a DC positive (+) plate. The plate accepts an M8 hex bolt and nut. See image B.
- GSLC models used with the GS3548E inverter do not use the DC positive plate. The cable lugs are connected to the DC disconnect, which uses a threaded M8 stud. See image C.
- All GSLC models connect the battery negative (-) cables to the shunt, which is threaded for 3/8" bolts. See image D.

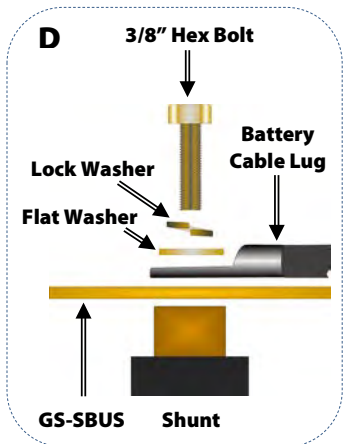
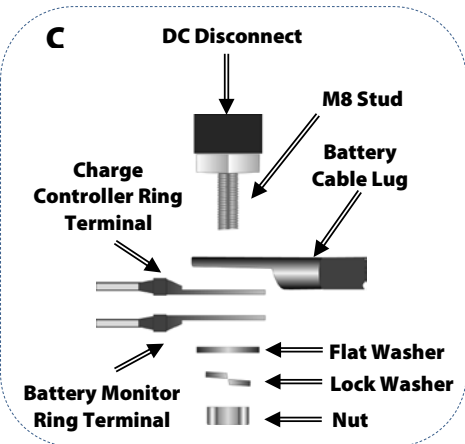
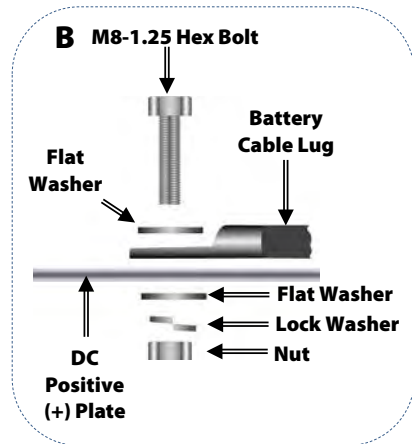
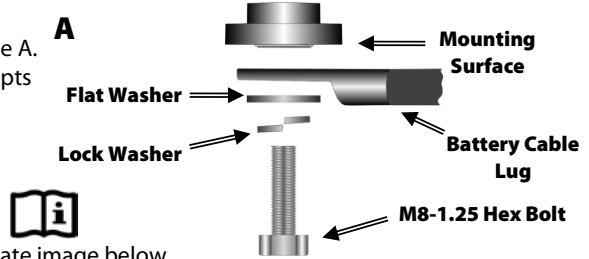

Figure 16 DC Cable Hardware (Radian inverter)

AC Wiring



WARNING: Shock Hazard

- Ensure there is no more than one AC neutral-ground bond at any time. Local or national codes may require the bond at the main panel only.
- The GSLC is equipped with its own bond, which may need to be removed.



IMPORTANT:

The installer is responsible for providing overcurrent protection. The AC input and output must be protected with branch-rated circuit breakers of up to 50 Aac maximum size to meet local code requirements.

The Radian inverter/charger's AC terminal block has six positions for AC wires. The minimum recommended size is 10 mm² or #8 AWG (0.013 in²). Larger wire gauges may be required for specific conditions. The largest size that can be used with the terminals is 16 mm² or #6 AWG (0.021 in²) wire. The inverter makes its AC connections using spring-loaded clamps. It is necessary to strip approximately 1.3 cm (½ inch) of insulation from the end of each wire. Other tools are not required.

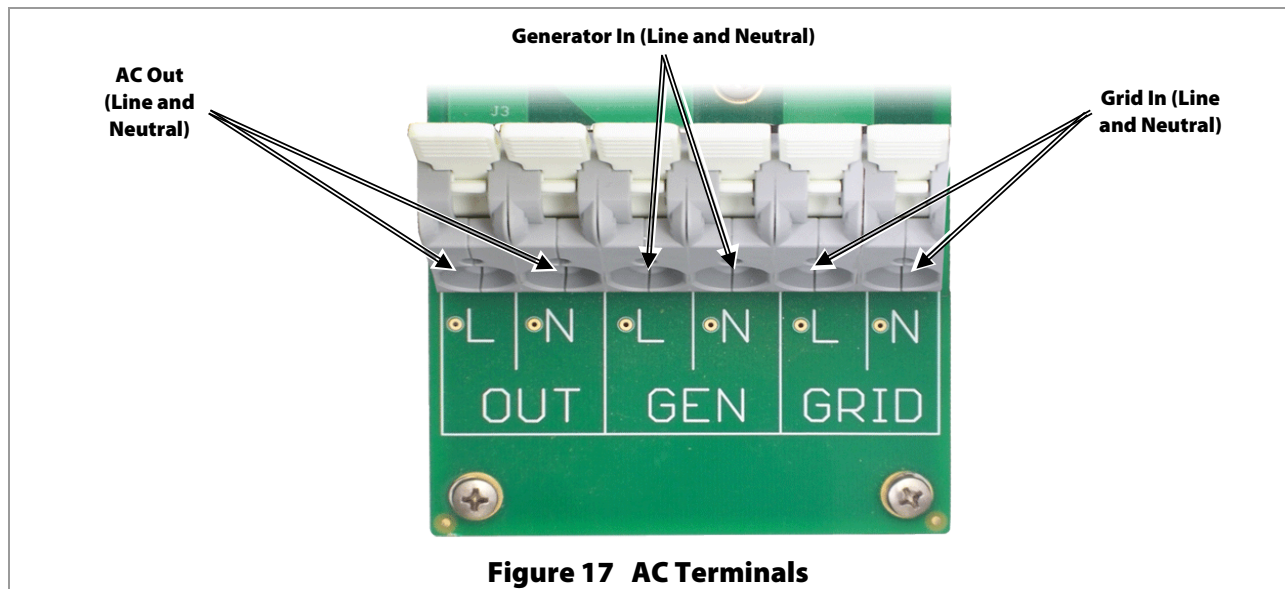

Figure 17 AC Terminals

The terminals labeled **L** are used to connect to the “hot” or “line” wires. All system wiring must comply with national and local codes and regulations.

Three neutral (**N**) terminals are available. These terminals are electrically common. Any of them can be used to connect to neutral wires from various parts of the system. The most common connections are to the neutral bus on the main panel or utility grid service, the neutral bus on the output load panel, the neutral bus in the GSLC, and the neutral wire from a generator.

The Radian can accept input voltages that range between (nominal) 220 Vac, 230 Vac, or 240 Vac (single-phase only). The range of input acceptance may need to be adjusted to the nominal voltage of the system so that inappropriate voltages are not accepted. The AC source(s) can power both battery charger and loads if sized correctly. Use the source amperage and the charger size to determine actual maximum draw. Size the input circuit breakers according to these specifications.

The terminals labeled **OUT** are used to connect the inverter to the load circuits. These terminals also transfer power from an AC source if it is available. Size the load circuit breakers accordingly.

A Ground Terminal Bus Bar (TBB) is also available if multiple ground connections are needed (see Figure 14 on page 19).



WARNING: Shock Hazard

During an error shutdown, the inverter's output terminals are not live. However, if the inverter recovers from a shutdown, the terminals will become live without notice. Several error shutdowns can be recovered automatically, including **Low Battery V**, **High Battery V**, and **Over Temperature**. See the Troubleshooting section and the list of error messages in the *Radian Series Inverter/Charger Operator's Manual* for more information.

AC Sources

The inverter's transfer relay is normally set to provide inverter power to the output. The conditions for AC acceptance are defined by the inverter's programmed settings and AC input mode. The relay will switch to transfer the AC source power to the output when the AC acceptance conditions are met.

The Radian inverter has connections for two AC sources, **GEN** (generator) and **GRID**, for ease of installation. Each source is transferred with a separate relay. However, internally it can only connect to one AC source at a time. It cannot use both utility grid and generator power at the same time. If presented with two sources of power, the default setting is to accept the source connected to the **GRID** terminals. The source priority can be changed using the system display. 

NOTE: The terminals are labeled due to common conventions, not inverter requirements. The **GEN** terminals can accept grid power if necessary. The opposite is also true. Each input can accept any AC source as long as it meets the requirements of the Radian and the selected input mode, with the following exception.



IMPORTANT:

The generator must be connected to the **GEN** terminals if using either the MATE3's Advanced Generator Start (**AGS**) function or the Radian's **GenAlert** auxiliary function. If the input priority is set to **GRID** and the **GRID** terminals are energized, an automatically controlled generator will shut down. This prevents an automatic generator from working correctly when using the **GRID** terminals.

NOTE: If an AC source is present on the priority input, the second input cannot accept another source for any reason. This is true even if the inverter has not accepted the priority source. The behavior is the same whether the first source was rejected for quality issues or because of programmed settings.

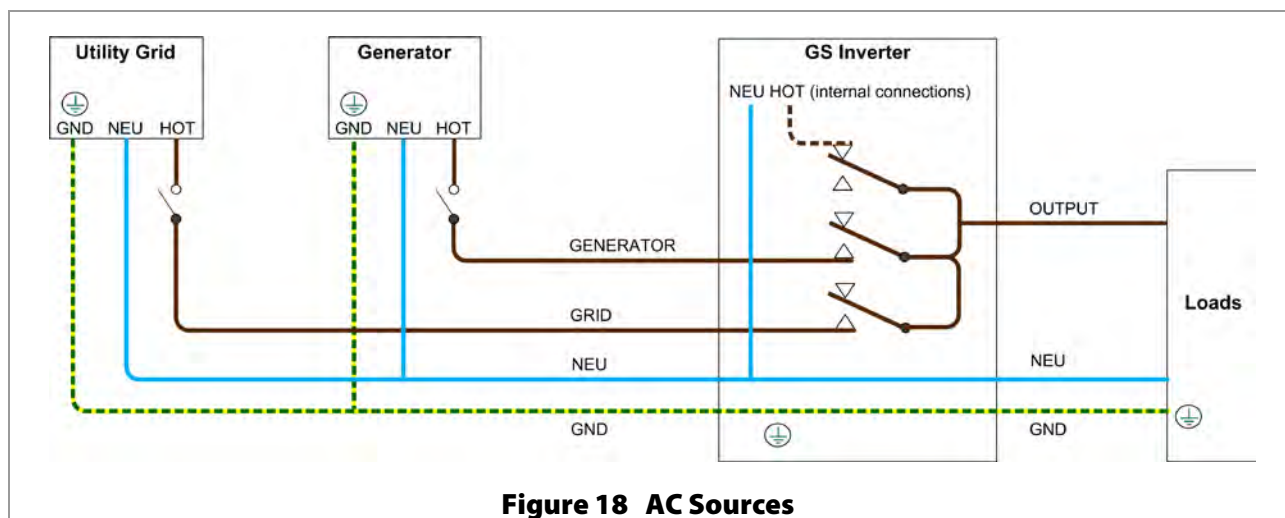

Figure 18 AC Sources

Installation

Accessory Wiring

The upper board has ports for both the Remote Temperature Sensor (RTS) and the system display. The system display port is labeled Remote. The RTS port is labeled Battery Temp.

If a HUB Communications Manager is in use, it occupies the inverter's Remote port. The system display plugs into the HUB product.

MATE3 or HUB cable (RJ45, 8-conductor, CAT5 non-crossover)

RTS cable (RJ11, 4-conductor, telephone)

See the Operator's Manual for functional information on the RTS.

When a HUB Communications Manager occupies the inverter's Remote port, the system display connects directly to the HUB's MATE port.

Inverters connect to communications manager ports 1 and above. Charge controllers and other devices connect to additional ports after the last inverter is connected. See Stacking on page 27 for information on connecting inverters.

Figure 19 Accessory Connections

The **ON/OFF INV** jumper bridges two pins. This jumper (J3) parallels the two **Switch INV** terminals on the terminal block. If either set of connections is closed, the inverter is on. (Although the jumper is factory-installed to the on position, the inverter is given an off command before leaving the factory and will initially be off.)

If the Radian is inverting, removing the jumper will turn it off. To remove the jumper, use long-nose pliers or a similar tool.

Once the plastic **ON/OFF INV** jumper has been removed, the **Switch INV** terminals on the terminal block can be used to wire a manual on/off switch.

These terminals can also be used to control an Emergency Power Off (EPO) device instead of a standard switch.

Figure 20 ON/OFF Jumper and Connections

AUX Wiring

The Radian inverter has two sets of terminals which can respond to different criteria and control many functions. These include cooling fans, vent fans, load diversion, fault alarms, and the Advanced Generator Start (AGS) function.

The **12V AUX** terminals are a switched 12 Vdc power supply. They can control any of the Auxiliary Output functions available in the MATE3.

The **12V AUX** terminals can supply up to 0.7 amps at 12 Vdc (8.4 watts). This is sufficient to drive a small fan or a relay controlling a larger device. The terminals accept wire up to #14 AWG (0.0032 in²) or 2.5 mm². This circuit contains electronic overcurrent protection, which resets after being overloaded. No additional fuses are required for the 12V AUX terminals.

The **RELAY AUX** terminals are “dry” relay contacts with no voltage. Their most common function is to serve as a switch for the start circuit of an automatic generator using the generator control functions. However, they can be programmed for other auxiliary functions as well. These terminals can conduct up to 10 amps at up to 30 Vdc or 250 Vac.



CAUTION: Equipment Damage

This circuit has no overcurrent protection. A fuse of no larger than 10 amps must be installed to protect the circuit. Since the internal circuitry of the **RELAY AUX** terminals does not incorporate overcurrent protection, it is the responsibility of the installer to ensure the circuit is protected. Internal failure that results from lack of protection is not covered by the Radian warranty.

Each set of terminals has its own set of programmed criteria.

NOTE: The menus for each set of terminals have identical options available, but can control independent functions. For example, the **RELAY AUX** terminals can be used for generator control, while the **12V AUX** terminals can simultaneously be used to control a vent fan in the battery box.

The control logic for the terminals is not always located in the same device. Radian Auxiliary functions are located within the inverter itself and are described with other inverter functions. Although inverter-based functions require the system display for programming, they will function even if the display is removed. However, AGS programming is located within the system display and will not work if the display is removed. Other devices may also be able to control the terminals. For generator control, see page 26.

In this example, the **12V AUX** terminals directly drive a 12-volt vent fan. The + and – wires on the fan are connected to the **AUX** terminals.

NOTE: If another device is used, such as a larger fan, it must not draw more than 0.7 amps.

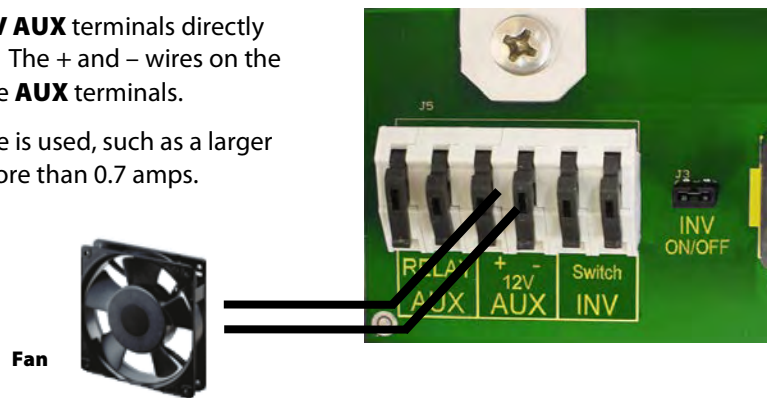
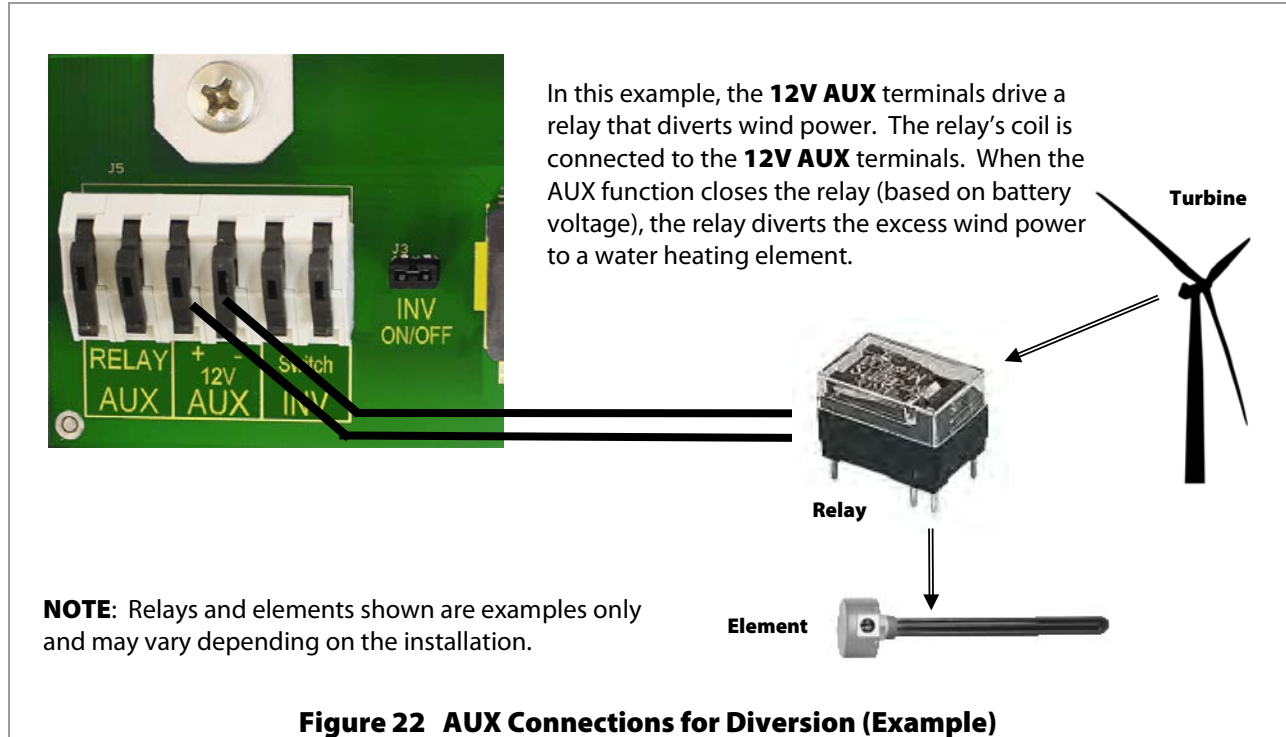

Figure 21 AUX Connections for Vent Fan (Example)

Installation



Generator Control

Either set of Radian AUX terminals can provide a signal to control an automatic-start generator. The control function can be **Advanced Generator Start** (AGS), which is situated in the system display. AGS can start the generator using settings from the system display, or it can use battery readings from the FLEXnet DC battery monitor. Alternately, the control function can be **Gen Alert**, which is a simpler function based directly in the Radian inverter. The choice of control function depends on system needs and the capabilities of each device.

The generator must be an electric-start model with automatic choke. It is recommended to have “two-wire” start capability.

The **RELAY AUX** terminals can most easily perform two-wire generator start. A two-wire-start generator is the simplest type, where the cranking and starting routine is automated. It usually has a single switch with two positions that is turned ON to start, OFF to stop.

Two-Wire-Start (RELAY AUX Terminals)

The **RELAY AUX** terminals can be wired in place of the generator’s start switch as shown in Figure 23. This method is only advised if the generator’s starting circuit is triggered by continuity. (This circuit must use fewer than 10 amps.)



CAUTION: Equipment Damage

This circuit has no overcurrent protection. A fuse of no larger than 10 amps must be installed to protect the circuit. Since the internal circuitry of the **RELAY AUX** terminals does not incorporate overcurrent protection, it is the responsibility of the installer to ensure the circuit is protected. Internal failure that results from lack of protection is not covered by the Radian warranty.

In other cases, or in the case of a three-wire-start generator, the inverter should use the **12V AUX** terminals instead, in conjunction with a three-to-two wire converter. (See pages 27 and 28.)

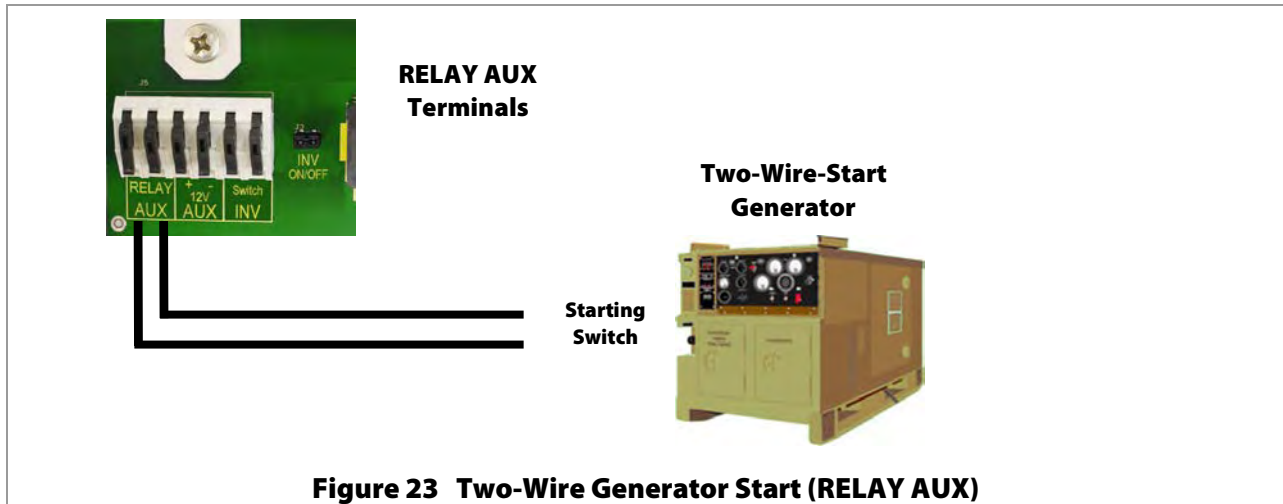

Two-Wire-Start (12V AUX Terminals)

The 12 Vdc signal provided by the **12V AUX** terminals can be switched on and off to provide a start signal. It is not usually recommended to connect the **AUX** terminals directly to the generator, but to use the **12V AUX** terminals to energize the coil of a 12 Vdc automotive or similar relay.

The OutBack FLEXware Relay Assembly depicted in Figure 24 is sold for this purpose. The relay contacts can serve in place of the generator’s start switch. The battery shown in Figure 24 is shown for clarity. Usually it is part of the generator’s internal starting circuit and is not an external component.

The drawing below is one example of a possible arrangement. Specific arrangements, relays, and other elements depend on the requirements of the installation and of the generator.

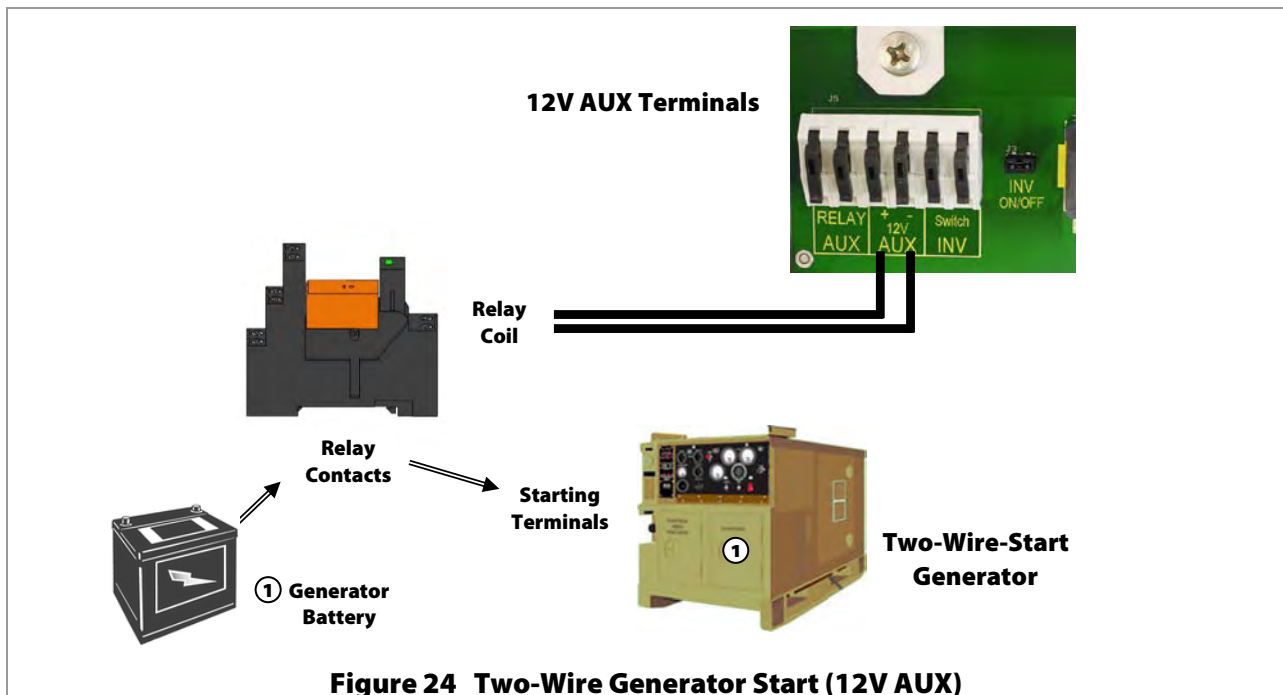

Installation

Three-Wire-Start

A “three-wire-start” generator has two or more starting circuits. It usually has a separate switch or position for cranking the generator. A three-wire generator has fewer automated functions than a two-wire. It usually requires multiple controls for starting, running, or stopping. The inverter terminals cannot control this type of generator without using a three-wire to two-wire conversion kit.

Atkinson Electronics (<http://atkinsolelectronics.com>) is one company that makes these kits. The Atkinson GSCM-Mini is intended to work with OutBack inverters.

NOTE: The conversion kit requires a 12-volt signal which the **RELAY AUX** terminals cannot provide. The **12V AUX** terminals may be used to operate the conversion kit, as shown in Figure 25 .

If the **AUX** terminals are being used for another purpose, it may be necessary for the **RELAY AUX** terminals to control an external relay and 12-volt source in conjunction with the conversion kit. The wiring and requirements for this arrangement will depend on the circumstances.

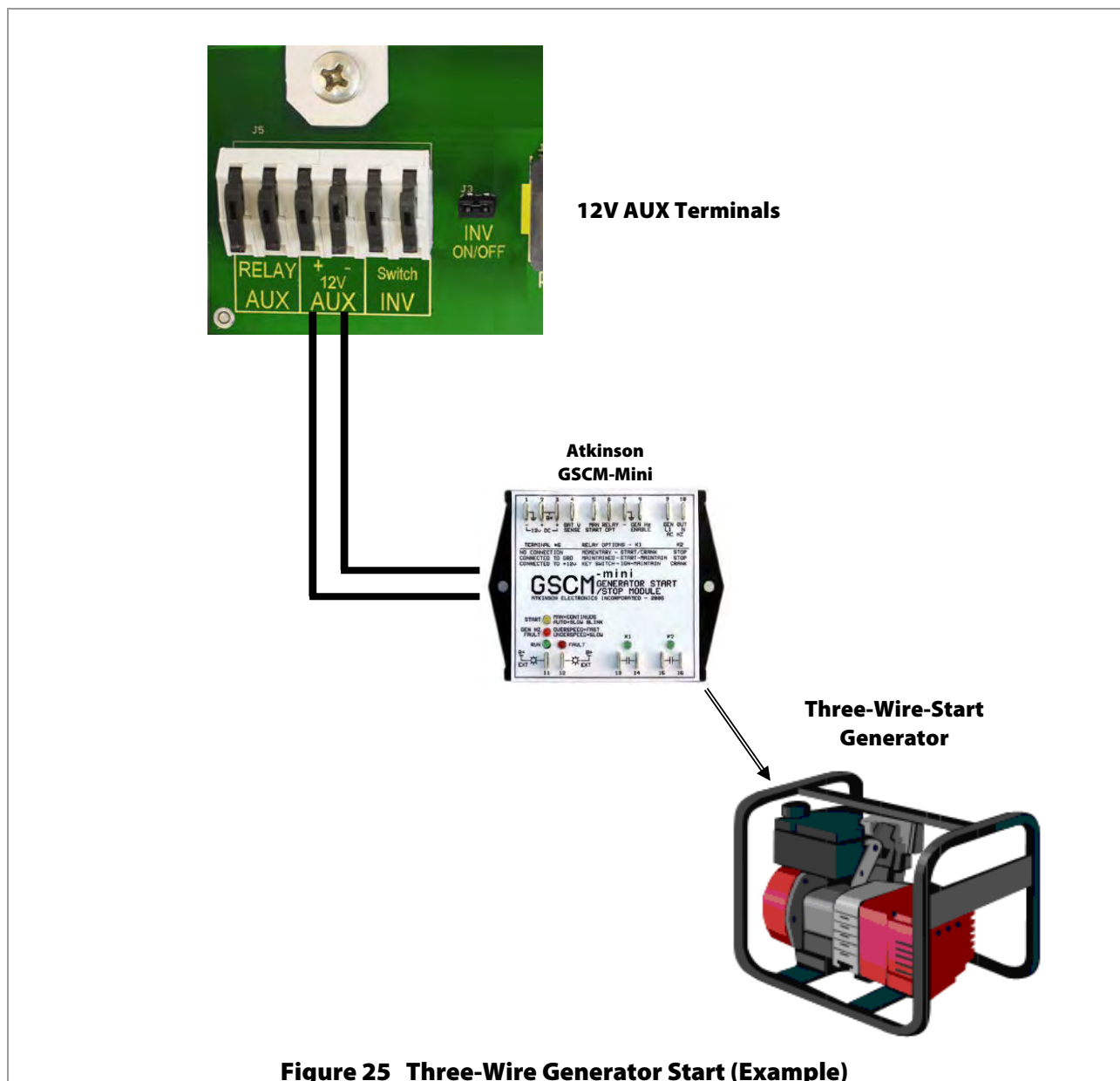

Figure 25 Three-Wire Generator Start (Example)

AC Configurations

Single-Inverter

Figure 26 (below) shows the general wiring of the Radian inverter and the AC system connected to it. This figure is not a physical representation of the inverter and does not depict the GSLC.

Figure 27 (see next page) shows the locations of AC and network connections. This figure is a physical diagram for wiring the GSLC, network components, and external AC devices with the inverter.

- All overcurrent devices in permanent installations must be sized for 50 Aac or less.
- All wiring in permanent installations must be sized for 50 Aac or more.
- All output circuit breakers must be sized appropriately for loads and inverter wattage.
- The Radian inverter has wiring connections for two AC sources, but it can only accept one source at a time.

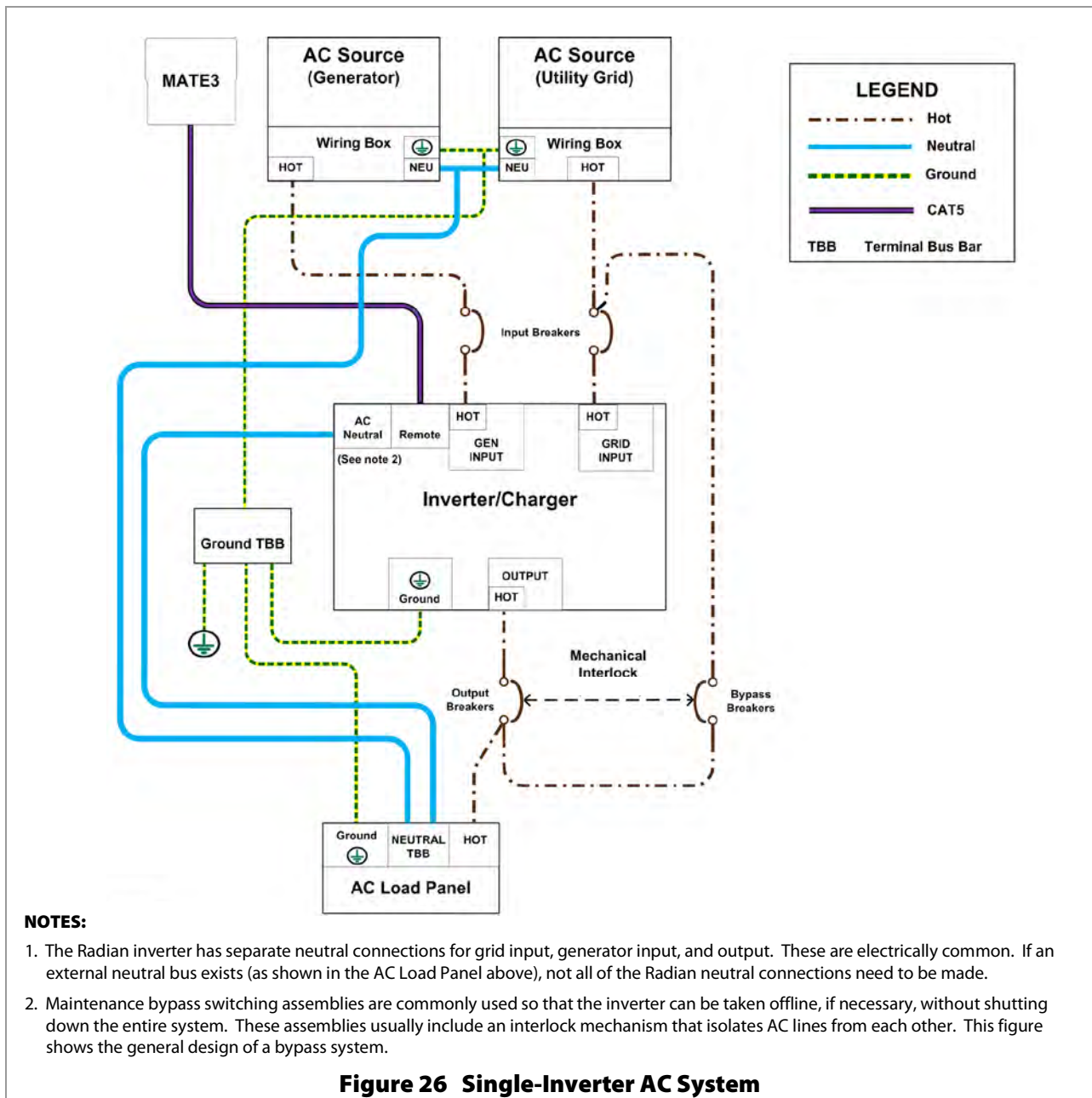

Installation

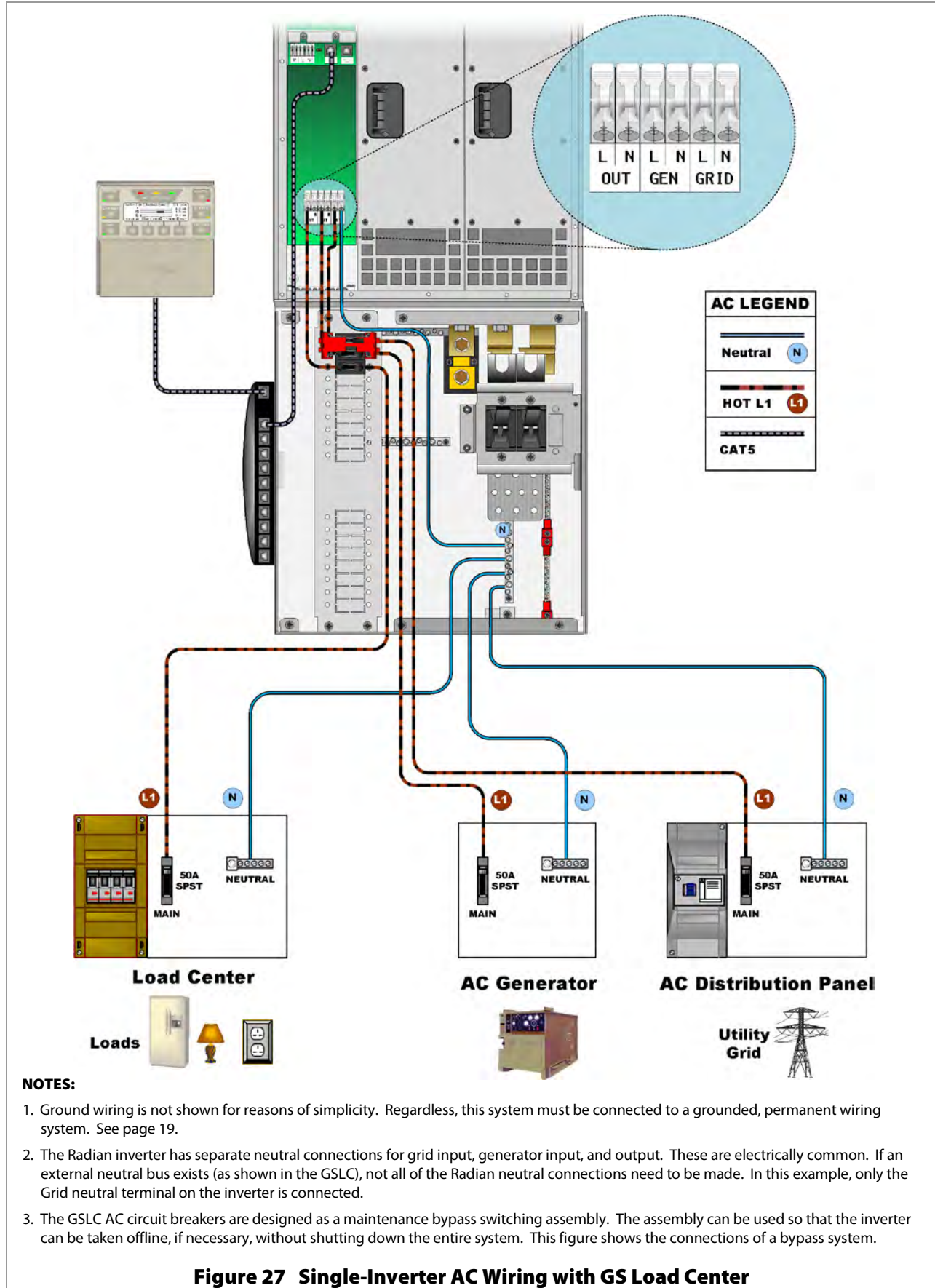

Multiple-Inverter AC Installations (Stacking)

Installing multiple inverters in a single AC system supports larger loads than a single inverter can handle. This requires stacking. Stacking refers to how the inverters are wired within the system and then programmed to coordinate activity. Stacking allows all units to work together as a single system. The GS3548E and GS7048E models can stack up to ten units in parallel. For three-phase output, up to nine models can be stacked, three per phase.

Stacking Connections

Stacking requires an OutBack communications manager and a system display.

- A system of four or fewer units may use the HUB4 Communications Manager.
- A system of up to ten units requires either the HUB10 or HUB10.3 Communications Manager.
- A three-phase system with multiple inverters per phase requires the HUB10.3 Communications Manager.
- All interconnections between the products are made using CAT5 non-crossover cable.

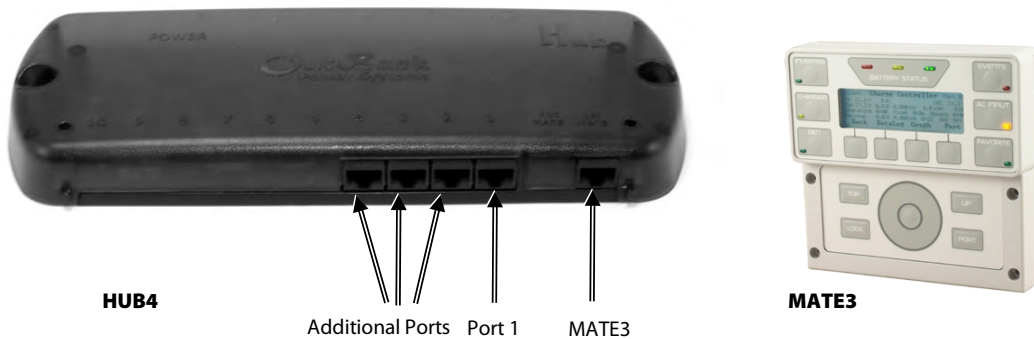

Figure 28 OutBack Communications Manager and System Display

Each inverter must be assigned a stacking mode, “master” or “slave”, depending on the configuration.

- The master provides the primary output phase. Other inverters in the system base their phase on that of the master. If the master shuts off, all other inverters also shut off. The master must sense and connect to an AC source before other inverters can connect. In all cases, the master inverter must be connected to port 1 on the communications manager.

In a parallel-stacked or OutBack-stacked system, the master tends to be the most heavily used unit.

- “Subphase masters” are used in three-phase systems. The A phase master cannot measure output loads and voltages on any other phase. The subphase masters for the B and C phases perform this monitoring and allow greater control over the system.

There are two types of slave modes.

- A “classic” slave is used for stacking when the slave operates semi-independently of the master. Although the master sets the phase relationship, the slave creates an output independent of the master.

Classic-stacked inverters can go into Search mode independently of the master if necessary.

This type of system is used for three-phase stacking with more than three inverters. The primary inverters are the master (A) and the subphase masters (B and C). Additional inverters are A-, B-, or C-phase slaves.

- An “OutBack” slave is used for parallel systems. All slaves are in phase with the master.

All slave outputs are pulse-width-matched to be precisely synchronized with the master inverter. This avoids potential backfeed.

OutBack slaves can be placed in Power Save mode when not in use. They are activated by the master inverter as needed. For this reason, the master is normally the only inverter to enter Search mode.

Installation

Connect all units other than the master to ports 2 and above on the communications manager.  The system display may have other port restrictions pertaining to stacking. In general, it is always important to keep track of units and ports for programming purposes.

Programming involves using the system display to assign a status and stacking value to the inverter on each port. The stacking assignments can be changed at any time as long as the master is connected to port 1.



IMPORTANT:

- The Radian GS7048E can be stacked with the Radian GS3548E in either a parallel or a three-phase configuration. To optimize the Power Save function, GS3548E inverters should have higher rank numbers than any GS7048E inverter. This is true regardless of the quantity of either model. In addition, the GS3548E should not be the master inverter in a mixed system.
- The master inverter must always be connected to port 1 on the communications manager. Connecting it elsewhere, or connecting a slave to port 1, will result in backfeed or output voltage errors which will shut the system down immediately.
- Installing multiple inverters without stacking them (or stacking them incorrectly) will result in similar errors and shutdown.
- Although stacking allows greater capacity, the loads, wiring, and overcurrent devices must still be sized appropriately. Overloading may cause circuit breakers to open or the inverters to shut down.

Parallel Stacking (Dual-Stack and Larger)

In parallel stacking, two or more inverters are stacked to create a single, common AC bus as shown in Figure 29.

- The slave outputs are controlled directly by the master and cannot operate independently.
- All inverters share a common input (AC source) and run loads on a common output.
- Slave inverters can go into Power Save mode when not in use. The master will activate individual slaves based on load demand. This reduces idle power consumption and improves system efficiency.
- Up to ten inverters may be installed in a parallel arrangement. The example on this page shows three inverters. The wiring diagrams on the next few pages show two.

Figure 30 (see page 34) shows the general wiring of the Radian inverters and the AC system connected to them. This figure is not a physical representation of the inverters and does not depict the GSLC.

Figure 31 (see page 35) shows the locations of AC and network connections. This figure is a physical diagram for wiring the GSLC, network components, and external AC devices with each inverter.

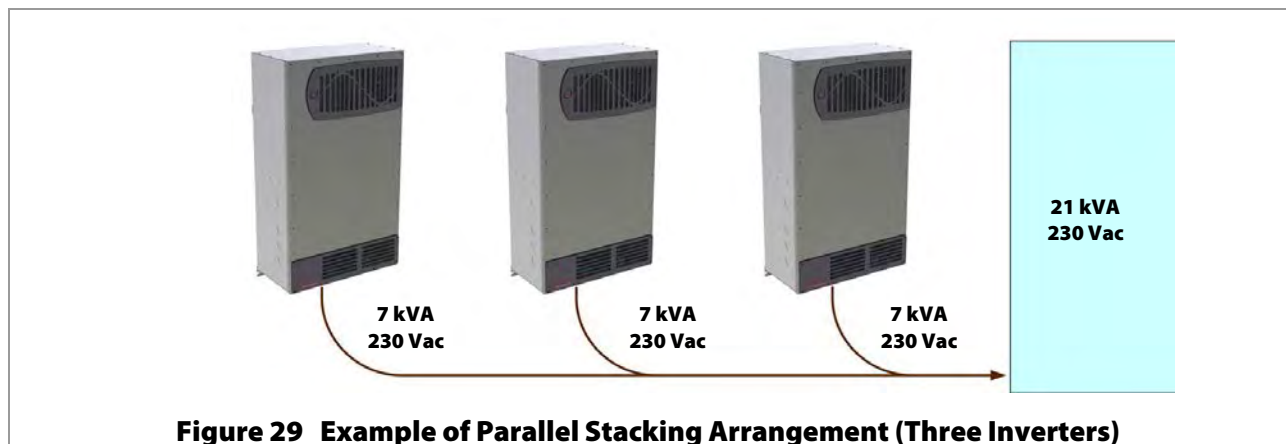

When installing a parallel system, the following rules must be observed.

- Parallel stacking requires the system display and a communications manager.
- One inverter, and one inverter only, is always the master and is programmed as **Master** in the MATE3 system display. This is the default setting.
- The master must be connected to port 1 of the communications manager. Other inverters must not be selected as master.
- All slave inverters, regardless of number, should be selected as **Slave** during programming.
- All overcurrent devices must be sized for 50 Aac or less.
- All wiring must be sized for 50 Aac or more.
- All output circuit breakers must be sized appropriately for loads and inverter wattage.
- The AC input (generator or utility grid) must be a single-phase output at the proper voltage and frequency.
- The input/output bypass kit for the GS Load Center cannot be used. See page 10 for more information.

Installation

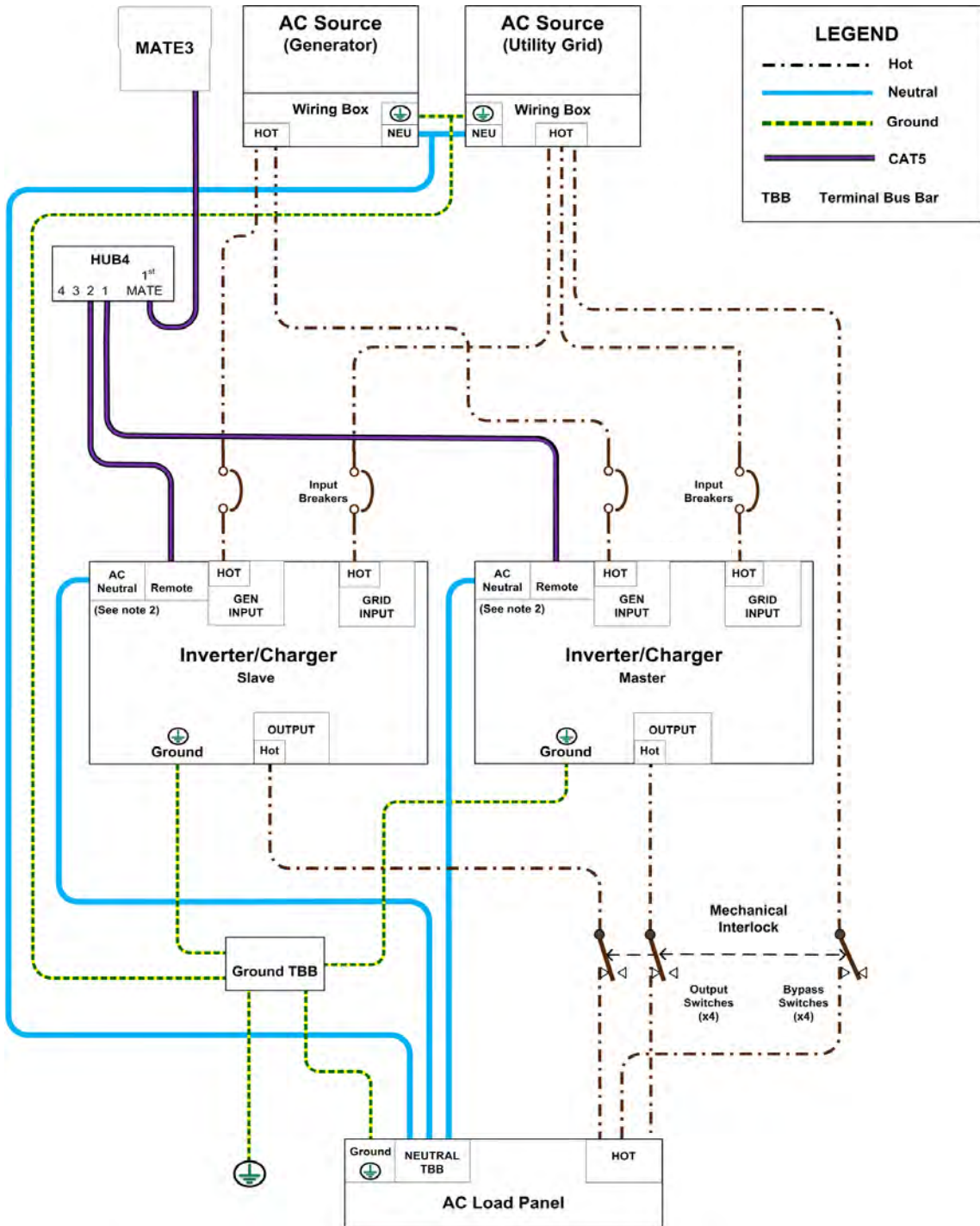

NOTES:

1. The Radian inverter has separate neutral connections for grid input, generator input, and output. These are electrically common. If an external neutral bus exists (as shown in the AC Load Panel above), not all of the Radian neutral connections need to be made.
2. Maintenance bypass switching assemblies are commonly used so that the inverter can be taken offline, if necessary, without shutting down the entire system. These assemblies usually include an interlock mechanism that isolates AC lines from each other. This figure shows the general design of a bypass system.
3. When multiple inverters are stacked, the GS Load Center (GSLC) for each inverter can be wired together to serve as a common input conduit box and AC load center. However, the GSLC bypass switching assemblies are only sized for single inverters and cannot work in conjunction with each other. The GSLC bypass assemblies should not be used with multiple inverters present. (See page 10.) An external bypass assembly must be used instead. Larger external assemblies are available from other manufacturers.

Figure 30 Parallel AC System

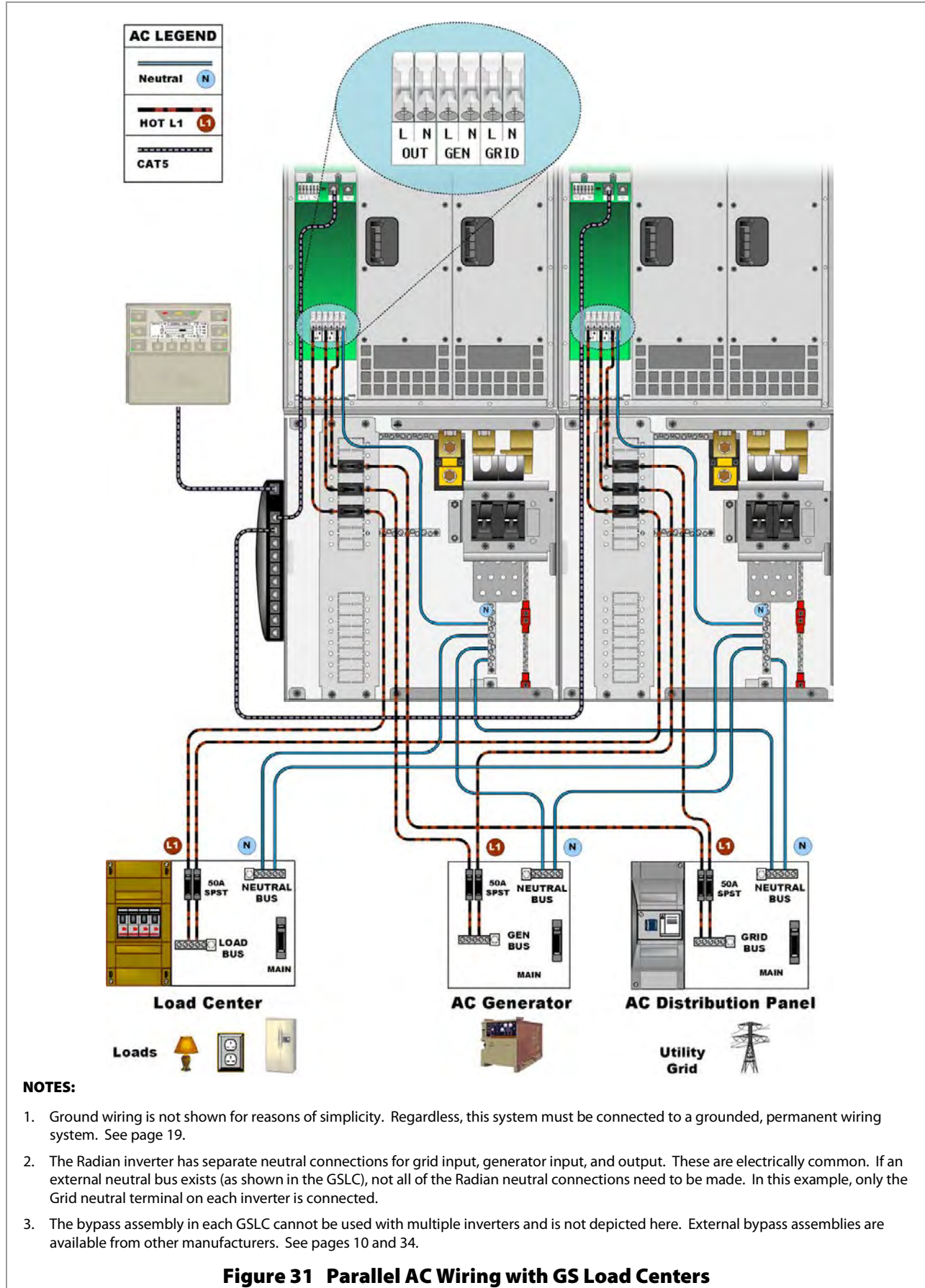
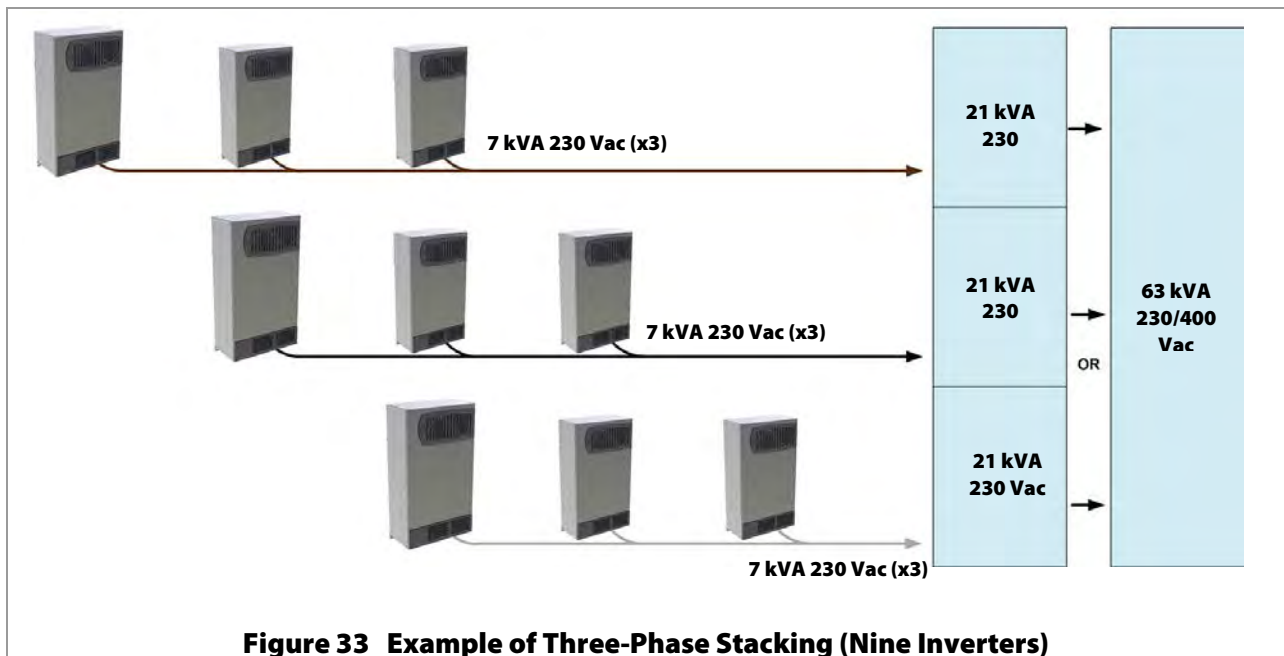
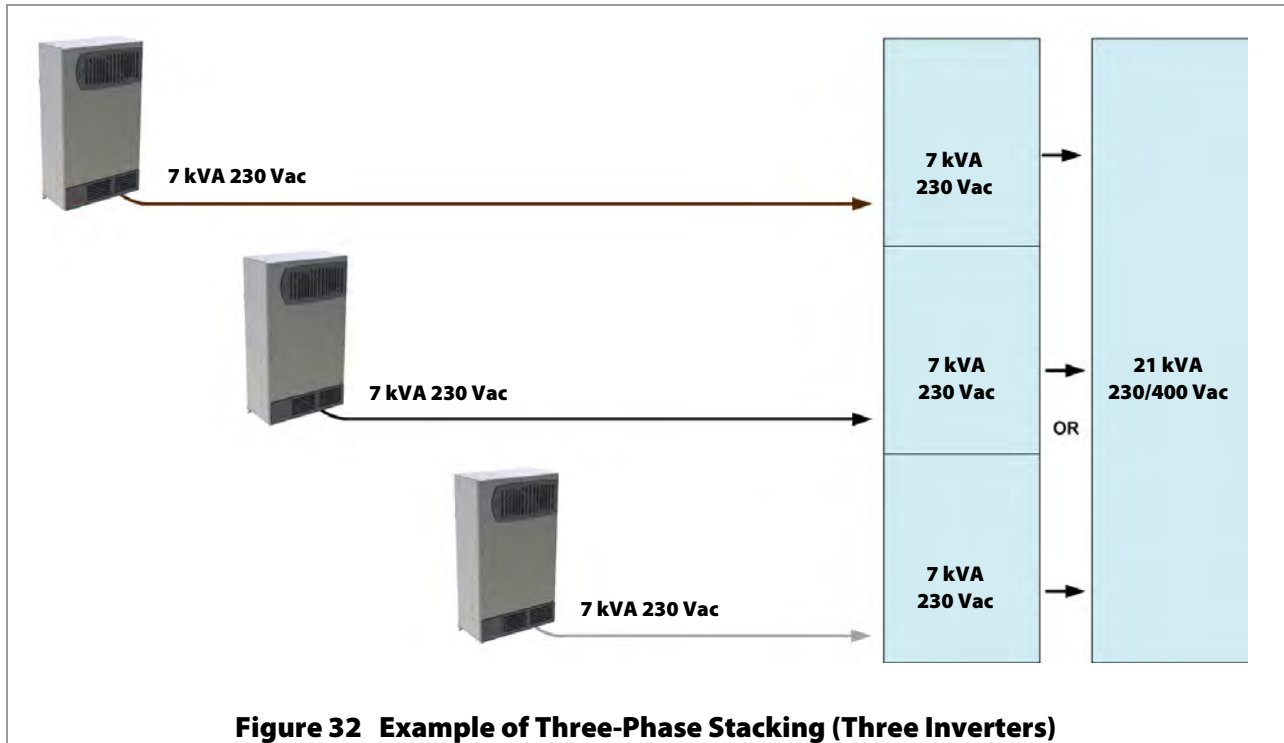

Figure 31 Parallel AC Wiring with GS Load Centers

Three-Phase Stacking

In three-phase stacking, three or more inverters are stacked to create three 230 Vac outputs (or equivalent voltage) in a wye configuration as shown below.



- The three outputs operate independently of each other. Each can run in independent Search mode if desired. This does not normally occur when three-phase loads are connected.
- The output of each inverter is 120° out of phase from the others. Any two outputs produce 400 Vac between them. The outputs can be used to power three-phase loads when all inverters work together.
- Up to nine inverters, three per phase, may be installed in a three-phase arrangement. Figure 32 shows three inverters, as do the figures on the following pages. Figure 33 shows nine inverters.

Figure 34 (see page 38) shows the general wiring of the Radian inverters and the AC system connected to them. This figure is not a physical representation of the inverters and does not depict the GSLC.

Figure 35 (see page 39) shows the locations of AC and network connections. This figure is a physical diagram for wiring the GSLC, network components, and external AC devices with each inverter.

When installing a three-phase system, the following rules must be observed.

- Three-phase stacking requires the system display and an OutBack communications manager. 
 - ~ Three-phase stacking with only three inverters can be performed with any HUB product.
 - ~ Three-phase stacking with more than three inverters requires a HUB10.3 Communications Manager.
- One inverter, and one inverter only, is always the master and is programmed as **Master** in the MATE3 system display. This is the default setting.
- The master inverter must be connected to port 1 of the communications manager. Other inverters must not be selected as master.
- Two subphase master inverters are required regardless of whether any slave inverters are installed. One subphase master controls the phase B output. The other controls phase C. The inverters should be wired to the loads and to the AC sources in phase order.
- If a HUB4 or HUB10 is used, the B and C subphase master inverters can be connected to any port other than port 1.
- If a HUB10.3 is used, connect the inverters using the following rules.
 - ~ Any phase A slaves must be connected to either port 2 or port 3. They are programmed as **Slave**.
 - ~ The subphase master for phase B must be connected to port 4. It is programmed as **B Phase Master**.
 - ~ Any phase B slaves must be connected to either port 5 or port 6. They are programmed as **Slave**.
 - ~ The subphase master for phase C must be connected to port 7. It is programmed as **C Phase Master**.
 - ~ Any phase C slaves must be connected to either port 8 or port 9. They are programmed as **Slave**.
- All overcurrent devices must be sized for 50 Aac or less. All wiring must be sized for 50 Aac or more.
- All output circuit breakers must be sized appropriately for loads and inverter wattage.
- The AC input (generator or utility grid) must be 230/400 Vac at 50 Hz (a three-phase wye configuration).
- The input/output bypass kit for the GS Load Center cannot be used. See page 10 for more information.



IMPORTANT:

- The HUB4 and HUB10 literature states that it is necessary to move the jumper to the “three-phase” position. That statement does not apply to the Radian inverters. The jumper must be left in its original position.
- In the HUB10.3, the jumper must be moved to the position required by the HUB10.3 literature.

Installation

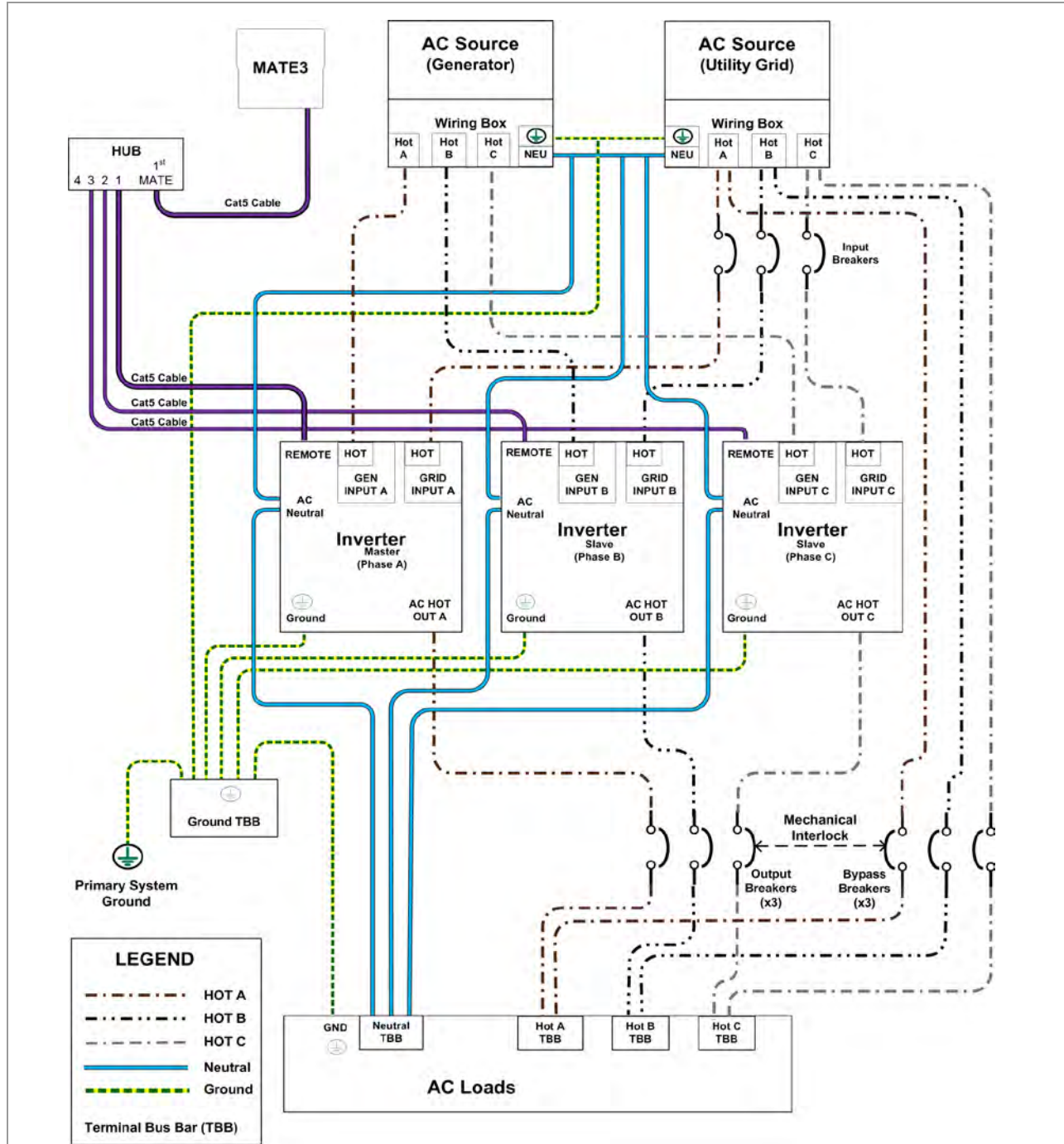

NOTES:

1. The Radian inverter has separate neutral connections for grid input, generator input, and output. These are electrically common. If an external neutral bus exists (as shown in the AC Load Panel above), not all of the Radian neutral connections need to be made.
2. Maintenance bypass switching assemblies are commonly used so that the inverter can be taken offline, if necessary, without shutting down the entire system. These assemblies usually include an interlock mechanism that isolates AC lines from each other. This figure shows the general design of a bypass system.
3. When multiple inverters are stacked, the GS Load Center (GSLC) for each inverter can be wired together to serve as a common input conduit box and AC load center. However, the GSLC bypass switching assemblies are only sized for single inverters and cannot work in conjunction with each other. The GSLC bypass assemblies should not be used with multiple inverters present. (See page 10.) An external bypass assembly must be used instead. Larger external assemblies are available from other manufacturers.
4. Wiring colors shown here may be different from wiring standards.

Figure 34 Three-Phase AC System

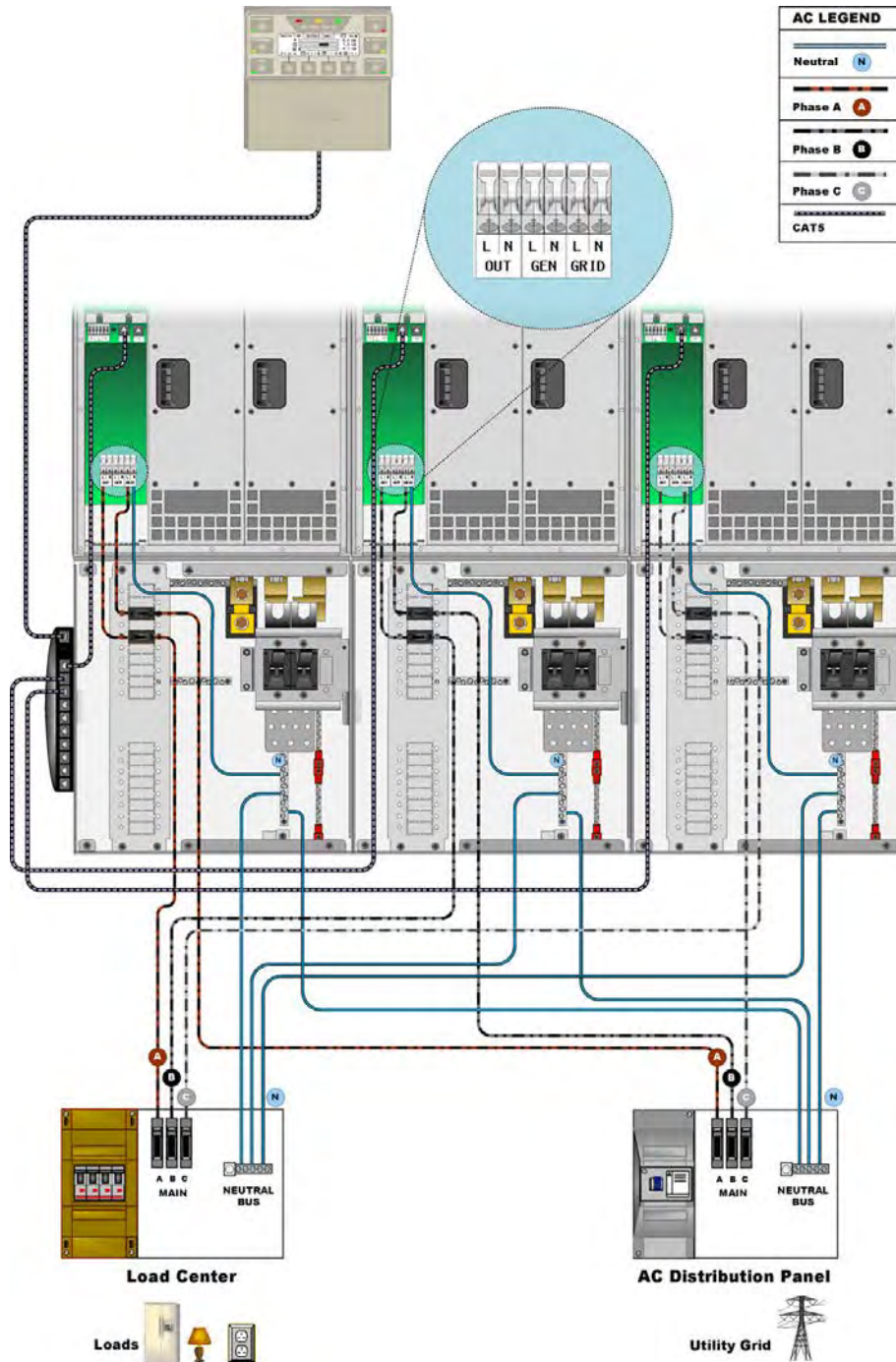

NOTES:

1. Ground wiring is not shown for reasons of simplicity. Regardless, this system must be connected to a grounded, permanent wiring system. See page 19.
2. Only one source (grid) is shown here for reasons of simplicity. The Radian inverter has connections for two AC input sources and can be wired accordingly, although the inverter can only accept one source at a time.
3. The Radian inverter has separate neutral connections for grid input, generator input, and output. These are electrically common. If an external neutral bus exists (as shown in the GSLC), not all of the Radian neutral connections need to be made. In this example, only the Grid neutral terminal on each inverter is connected.
4. The bypass assembly in each GSLC cannot be used with multiple inverters and is not depicted here. External bypass assemblies are available from other manufacturers. See page 10.
5. Wiring colors shown here may be different from wiring standards.

Figure 35 Three-Phase AC Wiring with GS Load Centers

Functional Test

Once the mounting, wiring, and other installation steps are completed, proceed to the *Radian Series Inverter/Charger Operator's Manual*. The *Operator's Manual* has steps for system commissioning. These include powering up and performing a functional test on the inverter system, as well as powering down and adding new devices to an existing system.

Refer to the *MATE3 System Display and Controller Owner's Manual* (or the appropriate system display manual) for programming instructions and menus.

When commissioning a grid-interactive system for use in Australia:

To meet the standard AS4777.3, the acceptance settings shall not exceed the following. The factory default settings meet these requirements.

Table 5 AS4777.3 Acceptance Settings

Minimum Voltage	Maximum Voltage	Minimum Frequency	Maximum Frequency
200 Vac	270 Vac	45 Hz	55 Hz

Preventative Maintenance



The Radian inverter requires almost no regular maintenance. However, OutBack recommends the following items on a periodic basis:

- Check all electrical connections periodically for tightness using the torque values from pages 19 through 22.
- Check the fan screens on each module and clear them of any debris.



Symbols, Terms, and Definitions

Symbols Used

	WARNING: Hazard to Human Life This type of notation indicates that the hazard could be harmful to human life.
	CAUTION: Hazard to Equipment This type of notation indicates that the hazard may cause damage to the equipment.
	IMPORTANT: This type of notation indicates that the information provided is important to the installation, operation and/or maintenance of the equipment. Failure to follow the recommendations in such a notation could result in voiding the equipment warranty.



MORE INFORMATION

When this symbol appears next to text, it means that more information is available in other manuals relating to the subject. The most common reference is to the *Radian Series Inverter/Charger Operator's Manual*. Another common reference is the system display manual.

Definitions

The following is a list of initials, terms, and definitions used with this product.

Table 6 Terms and Definitions

Term	Definition
12V AUX	Auxiliary connection that supplies 12 Vdc to control external devices.
AC	Alternating Current; refers to voltage produced by the inverter, utility grid, or generator
AIC	Ampere Interrupting Capacity; the rated maximum current a circuit breaker can interrupt without damage
AGS	Advanced Generator Start
AS	Australian Standards
Communications manager	Multi-port device such as the OutBack HUB4 or HUB10, used for connecting multiple OutBack devices on a single remote display; essential for stacking inverters
DC	Direct Current; refers to voltage produced by the batteries or renewable source
DVM	Digital Voltmeter

Terms and Definitions

Table 6 Terms and Definitions

Term	Definition
EPO	Emergency Power Off; a switching product used for emergency shutdown
GFDI	Ground Fault Detector Interruptor; a safety device for PV systems
GND	Ground; a permanent conductive connection to earth for safety reasons; also known as Chassis Ground, Protective Earth, PE, Grounding Electrode Conductor, and GEC
Grid/Hybrid™	System technology which optimizes both grid-interactive and off-grid options
Grid-interactive, grid-intertie, grid-tie	Utility grid power is available for use and the inverter is a model capable of returning (selling) electricity back to the utility grid
GSLC	GS Load Center; the wiring box for the Radian (GS) inverter
HUB	A line of OutBack communications manager products
IEC	International Electrotechnical Commission; an international standards organization
MATE3	An OutBack system display, used for monitoring, programming and communicating with the inverter
NEU	AC Neutral; also known as Common
Off-grid	Utility grid power is not available for use
PV	Photovoltaic
RELAY AUX	Auxiliary connection that uses switch (relay) contacts to control external devices.
RTS	Remote Temperature Sensor; accessory that measures battery temperature for charging
System display	Remote interface device (such as the MATE3), used for monitoring, programming and communicating with the inverter; also called "remote system display"
Utility grid	The electrical service and infrastructure supported by the electrical or utility company; also called "mains", "utility service", or "grid"



Index

A

AC Inputs	5, 18, 22, 23
AC Wiring	18, 22
Advanced Generator Start (AGS)	25
Applications	5
AS4777	40
Audience	3
AUX	17, 25, 41

B

Battery Bank	7
Sizing	8
Bypass	10

C

Clearance	11
Communication Cables	31
Communications Manager	24, 31, 41
Components	4
Conductor Size	
AC Conductors	22
DC Conductors	21
Ground Conductors	19
Cover	16

D

DC Terminals	17, 21
DC Wiring	20
Definitions	See Terms and Definitions
Dimensions	
Inverter	11
System	12
Diversion Control	26
Drawings	
Multiple AC Sources	23
Parallel-Stacked System	33
Three-Phase Stacked System	36
Transfer Relay	23
DVM	13, 41

E

Environmental Requirements	11
EPO	24, 42

F

Features	3
FLEXmax	4, 15
FLEXmax Extreme	15
Front Cover	16

G

Generator	23, 33, 36
Applications	5
Automatic Control	25
Requirements	9, 23
Three-Wire	28
Two-Wire	26, 27
Sizing	9
Wiring	22
GFDI	19, 42
Grid-Interactive	42
Grounding	18, 19
GSLC	4, 10, 12, 15, 42

H

HUB	4, 15, 31, 42
-----------	---------------

I

IEC	19, 42
Input Modes	6

J

Jumper J3	17, 24
-----------------	--------

L

Location	11
----------------	----

Index

M

Maintenance Bypass	10
Maintenance Checks	40
MATE and MATE2	4
MATE3	4, 15, 18, 42
AUX	25
Stacking	31
Mounting	
Components	15
Dimensions	11, 12
Orientation	11
Plate	13, 14
Multiple AC Sources	23

N

Neutral-Ground Bonding	9, 19, 22
------------------------------	-----------

P

Parallel Stacking	33
Ports, RJ45 and RJ11	18, 24

R

Remote System Display	42
Remote Temperature Sensor (RTS)	4, 18, 24
Renewable Energy	6
Ribbon Cables	17

S

Stacking	31
Parallel	33

Three-Phase	36
Switch	17, 24
Symbols Used	41
System Display	4, 24, 33, 36, 42

T

Temperatures	11
Terms and Definitions	41
Three-Phase Stacking	36
Tools Required	13
Torque Requirements	
DC Terminals	21
Ground Terminals	19
Transfer Relay	23

U

Utility Grid	23, 33, 36, 42
Applications	5
Wiring	22

W

Wiring	
AC Connections	18, 22
AUX Connections	25
DC Connections	20
Ground Connections	18, 19
Parallel Inverters	33
Single Inverter	29
Three-Phase Inverters	36

THIS PAGE INTENTIONALLY LEFT BLANK.

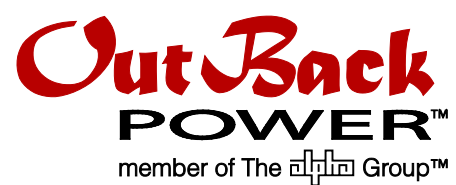

Masters of the Off-Grid.™ First Choice for the New Grid.

Corporate Headquarters
17825 – 59th Avenue N.E.
Suite B
Arlington, WA 98223 USA
+1.360.435.6030

European Office
Hansastrasse 8
D-91126
Schwabach, Germany
+49.9122.79889.0